

*Thank You for Selecting
The Powerful Self-Propelled High Wheel Mower*

Operator Owner's Manual

HW650SP
Patent Pending

2 Accessories

**Mulching Kit
P/N 510202**
Reduces lawn clippings to fine nutrient-rich particles that filter down to the soil.

**Grass Catcher Kit
P/N 510223**
Easily convert your mower to bag grass and leaves.

3 Specifications

HW650SP

Engine: HP	6.5 HP (4.85 kW)
Engine: Type	B&S OHV
Engine: Fuel cap.	1.6 qt. (1.5 L)
Engine: Oil Cap.	0.63 qt. (0.6 L)
Weight: Unit	154 # (70.0 Kg)
Weight: Shipping	167 # (77.7 Kq)

UNIT SIZE: OVERALL LENGTH - 82.5" (2.09 m)
OVERALL WIDTH - 32.0" (0.81m)
OVERALL HEIGHT - 43" (1.09m)

5

IN THE INTEREST OF SAFETY



BEFORE STARTING ENGINE, READ AND UNDERSTAND THE "ENTIRE OPERATOR'S MANUAL & ENGINE MANUAL."

THIS SYMBOL MEANS WARNING OR CAUTION. DEATH, PERSONAL INJURY AND/OR PROPERTY DAMAGE MAY OCCUR UNLESS INSTRUCTIONS ARE FOLLOWED CAREFULLY.

WARNING: The Engine Exhaust from this product contains chemicals known to the State of California to cause cancer, birth defects or other reproductive harm.

WARNING: DO NOT

- 1. **DO NOT** run engine in an enclosed area. Exhaust gases contain carbon monoxide, an odorless and deadly poison.
- 2. **DO NOT** place hands or feet near moving or rotating parts.
- 3. **DO NOT** store, spill or use gasoline near an open flame, or devices such as a stove, furnace, or water heater which use a pilot light or devices which can create a spark.
- 4. **DO NOT** refuel indoors where area is not well ventilated. Outdoor refueling is recommended.
- 5. **DO NOT** fill fuel tank while engine is running. Allow engine to cool for 2 minutes before refueling. Store fuel in approved safety containers.
- 6. **DO NOT** remove fuel tank cap while engine is running.
- 7. **DO NOT** operate engine when smell of gasoline is present or other explosive conditions exist.
- 8. **DO NOT** operate engine if gasoline is spilled. Move machine away from the spill and avoid creating any ignition until the gasoline has evaporated.
- 9. **DO NOT** transport unit with fuel in tank.
- 10. **DO NOT** smoke when filling fuel tank.
- 11. **DO NOT** choke carburetor to stop engine. Whenever possible, gradually reduce engine speed before stopping.

- 12. **DO NOT** run engine at excessive speeds. This may result in injury & /or damage to unit.
- 13. **DO NOT** tamper with governor springs, governor links or other parts which may change the governed engine speed.
- 14. **DO NOT** tamper with the engine speed selected by the engine manufacturer.
- 15. **DO NOT** check for spark with spark plug or spark plug wire removed. Use an approved tester.
- 16. **DO NOT** crank engine with spark plug removed. If engine is flooded, place throttle in "FAST" position and crank until engine starts.
- 17. **DO NOT** strike flywheel with a hard object or metal tool as this may cause flywheel to shatter in operation. Use proper tools to service engine.
- 18. **DO NOT** operate engine without a muffler. Inspect periodically and replace, if necessary. If engine is equipped with muffler deflector, inspect periodically and replace, if necessary, with correct deflector.
- 19. **DO NOT** operate engine with an accumulation of grass, leaves, dirt or other combustible material in the muffler area.
- 20. **DO NOT** use this engine on any forest covered, brush covered, or grass covered unimproved land unless a spark arrester is installed on the muffler. The arrester must be maintained in effective working order by the operator. In the State of California the above is required by law (Section 4442 of the California Public Resources Code). Other states may have similar laws. Federal laws apply on federal lands.
- 21. **DO NOT** touch hot muffler, cylinder, or fins

- because contact may cause burns.
- 22. **DO NOT** run engine without air cleaner or air cleaner cover.
- 23. **DO NOT** operate during excessive vibration!
- 24. **DO NOT** leave machine unattended while in operation.
- 25. **DO NOT** park machine on a steep grade or slope.

WARNING: DO

- 1. **ALWAYS DO** remove the wire from the spark plug when servicing the engine or equipment TO PREVENT ACCIDENTAL STARTING.
- 2. **DO** keep cylinder fins and governor parts free of grass and other debris which can affect engine speed.
- 3. **DO** pull starter cord slowly until resistance is felt. Then pull cord rapidly to avoid kickback and prevent hand or arm injury.
- 4. **DO** examine muffler periodically to be sure it is functioning effectively. A worn or leaking muffler should be repaired or replaced as necessary.
- 5. **DO** use fresh gasoline. Stale fuel can gum carburetor and cause leakage.
- 6. **DO** check fuel lines and fittings frequently for cracks or leaks. Replace if necessary
- 7. **Follow** engine manufacturer operating and maintenance instructions.
- 8. **Inspect** machine and work area before starting unit.

6 TABLE OF CONTENTS

SAFETY INSTRUCTIONS	2
GENERAL SAFETY	3
ASSEMBLY	4
LIT. BAG & CONTROLS	4
LABELS	4
OPERATION	5 - 7
MAINTENANCE	7 - 9
PARTS DRAWING & LIST	10 - 11
TROUBLESHOOTING	12
WARRANTY PROCEDURE	12

7 SOUND

Sound tests conducted were in accordance with 2000/14/EEC and were performed on 2/21/2002 under the conditions listed:
 NOTE: Sound power level listed is the highest value for any model in this manual. Please refer to serial plate on the unit for the sound power level for your model.

Sound level of 87 dBA at operator position



97

GENERAL CONDITION:	Sunny
TEMPERATURE:	49 °F (9.4 °C)
WIND SPEED:	8 MPH (12.9 kmh)
WIND DIRECTION:	South East
HUMIDITY:	53%
BAROMETRIC PRESSURE:	30.15" Hg (766mm Hg)

8 VIBRATION

VIBRATION LEVEL 0.44g

Vibration levels at the operators handles were measured in the vertical, lateral, and longitudinal directions using calibrated vibration test equipment. Tests were performed on 05/19/95 under the conditions listed:

GENERAL CONDITION:	Sunny
TEMPERATURE:	79 °F (26.4 °C)
WIND SPEED:	7 MPH (11 kmh)
WIND DIRECTION:	South West
HUMIDITY:	38%
BAROMETRIC PRESSURE:	30.25" Hg (768mm Hg)

For your safety and the safety of others, these directions should be followed:



Do not operate this machine without first reading owner's manual and engine manufacturer's manual.



Use of Ear Protection is recommended while operating this machine.



Use of Eye and Breathing protection is recommended when using this machine.

This cutting machine is capable of amputating hands and feet and throwing objects. Failure to observe the following safety instructions could result in serious injury or death.

I. General Operation

1. Read, understand, and follow all instructions on the machine and in the manual(s). Be thoroughly familiar with the controls and the proper use of the mower before starting.
2. Do not put hands or feet near or under rotating parts. Keep clear of the discharge opening at all times.
3. Only allow responsible individuals, who are familiar with the instructions, to operate the mower.
4. Clear the area of objects such as rocks, toys, wire, bones, sticks etc., which could be picked up and thrown by the blade.
5. Be sure the area is clear of other people before mowing. Stop mower if anyone enters the area.
6. Do not operate the mower when barefoot or wearing open sandals. Always wear substantial foot wear.
7. Do not pull mower backwards unless absolutely necessary. Look down and behind before and while moving backwards.
8. Do not operate the mower without proper guards, plates, grass catcher or other safety protective devices in place.
9. See manufacturer's instructions for proper operation and installation of accessories. Only use accessories approved by the manufacturer.
10. Stop the blade(s) when crossing gravel drives, walks, or roads.
11. Stop the engine (motor) whenever you leave the equipment, before cleaning the mower or unclogging the chute.
12. Shut the engine (motor) off and wait until the blade comes to complete stop before removing grass catcher.
13. Mow only in daylight or good artificial light.
14. Do not operate the mower while under the influence of alcohol or drugs.
15. Never operate mower in wet grass. Always be sure of your footing; keep a firm hold on the handle and walk; never run.
16. Disengage the self-propelled mechanism or drive clutch on mowers so equipped before starting the engine (motor).
17. If the equipment should start to vibrate abnormally, stop the engine (motor) and check immediately for the cause. Vibration is generally a warning of trouble.
18. Always wear safety goggles or safety glasses with side shields

when operating mower.

II. Slope Operation

Slopes are a major factor related to slip and fall accidents which can result in severe injury. All slopes require extra caution. If you feel uneasy on a slope, do not mow it.

DO:

Mow across the face of slopes; never up and down. Exercise extreme caution when changing direction on slopes.

Remove objects such as rocks, tree limbs, etc. Watch for holes, ruts, or bumps. Tall grass can hide obstacles.

DO NOT:

Do not mow near drop-offs, ditches, or embankments. The operator could lose footing or balance.
Do not mow excessively steep slopes.

Do not mow on wet grass. Reduced footing could cause slipping.

III. Children

Tragic accidents can occur if the operator is not alert to the presence of children. Children are often attracted to the mower and the mowing activity. Never assume that children will remain where you last saw them.

1. Keep children out of the mowing area and under the watchful care of a responsible adult.
2. Be alert and turn mower off if children enter the area.
3. Before and while moving backwards, look behind and down for small children.
4. Never allow children to operate the mower.
5. Use extra care when approaching blind corners, shrubs, trees, or other objects that may obscure vision.

IV. Service

1. Use extra care in handling gasoline and other fuels. They are flammable and vapors are explosive.
 - a) Use only an approved container.
 - b) Never remove gas cap or add fuel with the engine running. Allow engine to cool before refueling. Do not smoke.
 - c) Never refuel the machine indoors.
 - d) Never store the machine or fuel container inside where there is an open flame, such as a water heater.
2. Never run an engine inside a closed area.
3. Never make adjustments or repairs with the engine (motor) running. Disconnect the spark plug wire, and keep the wire away from the plug to prevent accidental starting.
4. Keep all nuts and bolts, especially blade attachment bolts, tight and keep equipment in good condition.
5. Never tamper with safety devices. Check their proper operation regularly.
6. Keep mower free of grass, leaves, or other debris build-up. Clean up oil or fuel spillage. Allow mower to cool before storing.
7. Stop and inspect the equipment if you strike an Object. Repair, if necessary, before restarting.
8. Never attempt to make wheel height adjustments while the engine (motor) is running.
9. Always disconnect electric mowers (live operated) before cleaning, repairing, or adjusting.
10. Grass catcher components are subject to wear, damage, and deterioration, which could expose moving parts or allow objects to be thrown. Frequently check components and replace with manufacturer's recommended parts, when necessary."
11. Mower blades are sharp and can cut. Wrap the blade(s) or wear gloves, and use extra caution when servicing them.
12. Do not change the engine governor setting or overspeed the engine.

11 ASSEMBLY



Read all safety and operating instructions before assembling or starting this unit.



PUT OIL IN ENGINE BEFORE STARTING.



DISCONNECT SPARK PLUG WIRE BEFORE ASSEMBLING UNIT.

Your Billy Goat High Wheel Mower is shipped from the factory in one carton, completely assembled.

12 LITERATURE ASSY P/N 500263

Literature Checklist

Owner's Manual

Check

Owner's Manual
510153

Warranty Card

Check

Warranty Card
400972

13 CONTROLS

Throttle Control

FIXED THROTTLE
Engine speed is factory set.

Speed Control

Push forward for faster speed, Pull back for slower speed

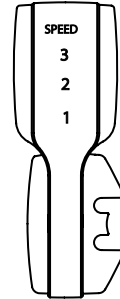

14 INSTRUCTION LABELS

These labels should be included on your Contour mower. If any of these labels are damaged, replace them before putting this equipment into operation. Item and part numbers are given to help in ordering replacement labels..



Label Do Not Fill While Engine Is Hot
Item 48 Part No.400268



Label Oil Chain
Item 62 PartNo.830502



Label Warning Guards
Item 63 Part No.900327



Label Drive/Blade
Item 101 PartNo.510174

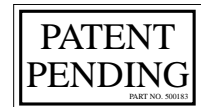

Label Patent Pending
Item 98 Part No.500183



Label Read Owner's Manual
Item 109 PartNo.890301



Label Danger Keep Hands and Feet Away
Item 61 PartNo.400424

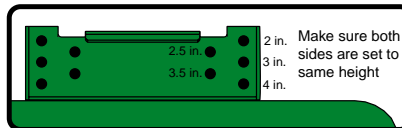

Label Cutting Hgt.
Item No. 58 Part No. 510147



Label Warning Mower
Item No. 60 Part No. 510206

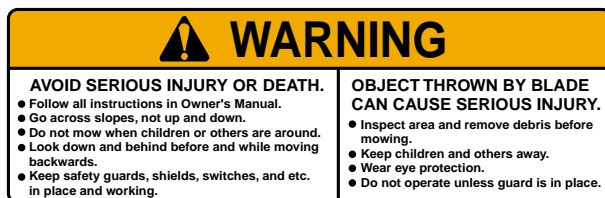

Label Mower Instruction Item No. 59 Part No. 510207

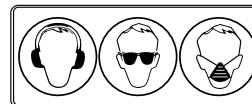

Label Ear Eye Breathing
Item No. 110 Part No. 890254



Label Danger Flying Material
Item No. 111 Part No. 810736

15 ENGINE LABELS

Briggs & Stratton

Read Owner's Manual Before Operating.
Lire le manuel d'utilisation avant la mise en route.
Vor Inbetriebnahme Bedienungs- und Wartungsanleitung lesen.
Favor leer las instrucciones de operacion antes de operar el motor.
Consultare il Manuale Uso e Manutenzione prima dell'utilizzo.
Las Skotselinstruktionen Innan Start.

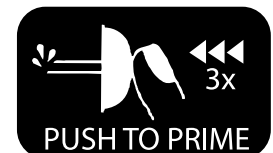

INTENDED USE: This unit is mainly designed for cutting grass. Some overgrown weeds, and taller grass may also be cut. Be sure to inspect work area and machine before operating. Make sure that all operators of this equipment are trained in general machine use and safety.

 Like all mechanical tools, reasonable care must be used when operating machine. Do not operate unit in areas where bystanders may be present.

 Do not operate if excessive vibration occurs. If excessive vibration occurs, shut engine off immediately and check for damaged or worn blade, loose blade jam nut, loose engine or lodged foreign objects. Note: See maintenance section for proper blade jam nut torque specifications.

16.1 STARTING



PUT OIL IN ENGINE BEFORE STARTING.

 **ENGINE:** See engine manufacturer's instructions for type and amount of oil and gasoline used. Engine must be level when checking and filling oil and gasoline.

ENGINE SPEED: Set at factory. The engine runs at a constant speed.

FUEL VALVE: Move fuel valve to "ON" position (when provided on engine).

1. Select desired cutting height before starting engine.
2. Place mower on a sidewalk or driveway where the mower blade is in an unloaded condition. If it must be started on the lawn, move mower over previously cut grass.
3. Be sure drive bail is not engaged.
4. Prime to choke. Prime is located in front of the engine.
5. Pull back on operator presence control, then pull back on starter rope slowly until resistance is felt. Then pull cord rapidly to start. Repeat if necessary.

16.2 CUTTING OPERATION

 **CAUTION:** The mower blade will be rotating whenever engine is running.

 **CAUTION:** Stop Blade when crossing gravel drives, walks or roads and under all conditions where thrown objects might be a hazard.

 **CLEARING A CLOGGED CUTTING DECK:** Turn engine off and wait for blade to stop completely. Disconnect spark plug wire.



Wearing durable gloves, remove clog.

Danger, the clog may contain sharp materials. Reconnect spark plug wire.

 **CAUTION:** Use extreme care when operating the blade. Inspect the work area for foreign objects that could cause damage to the unit or injure the operator if struck by the blade. Never operate the blade with bystanders in the work area.

16.3 CUTTING HEIGHT ADJUSTMENT

 **CAUTION: DO NOT** make cutting height adjustment when engine is running.

Cutting height can be adjusted from 2" to 4" by 1/2" increments by lowering or raising the deck. For easiest adjustment change the height from one side at a time. To change cutting height, remove lock pins, raise or lower deck to desired height, then reinsert lock pins. Repeat this step on other side

NOTE: Be sure that the deck is level. Running the deck out of level will result in poor cut quality and increased belt wear.



Fig. 1

16.4 PROPULSION

This unit is self-propelled, and is controlled by an operator presence control. To engage the wheel drive, push forward on the bail (back of the handle) and squeeze it against operator's handle. The drive is disengaged by releasing this bail. (See Fig. 2)



Fig. 2

**DRIVE
BAIL**

GROUND SPEED can be varied by selecting a higher or lower gear using the gear shift lever on top of the handle (See Fig. 3). Under most conditions cutting should be done in first or second gear. Third gear should be reserved for conditions where weeds and brush are thinned out or not as tall. The quality of the cut produced is directly related to the unit's ground speed during cutting. If the quality of the cut is not satisfactory (i.e. material left standing) you should shift into a lower gear during cutting. For improved control in confined areas, this machine can be pushed forward or backward by releasing the drive bail located at the back of the handle.



Fig. 3

16.5 FRONT CASTER LOCK

Front caster can be locked with a remote located on the rear of the machine for mowing on hillsides (fig. 4 & 5). **WARNING!** Never mow on any slope greater than 15 degrees. **ALWAYS** mow across the face of slopes; never up and down or diagonally.



To engage caster lock lift up and push forward on control rod.

Fig. 4



To disengage caster lock lift up and pull back on control rod.

Fig. 5

16.5 HILLSIDE MOWING

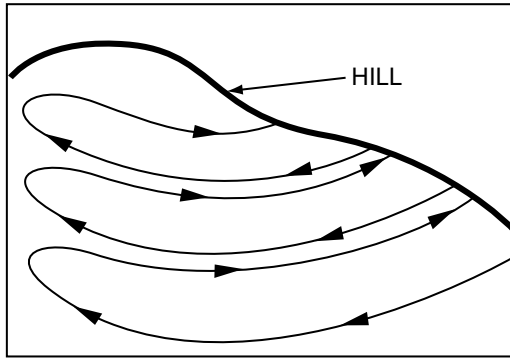

Fig. 5.1

⚠ WARNING! Never mow on any slope greater than 15 degrees. Always mow across the face of slopes; never up and down or diagonally see fig 5.1). DO NOT attempt sudden starts or stop when mowing on a slope. Avoid Sudden turns and use extreme caution when changing direction on a slope.

16.6 HANDLING & TRANSPORTING:

Using two people to lift machine is recommended. Lift holding the handle and front of deck. Secure in place during transport.

16.7 STORAGE

⚠ Never store engine indoors or in enclosed poorly ventilated areas with fuel in tank, where fuel fumes may reach an open flame, spark or pilot light, as on a furnace, water heater, clothes dryer or other gas appliance. **If engine is to be unused for 30 days or more, prepare as follows:**

⚠ Be sure engine is cool. Do not smoke. Remove all gasoline from carburetor and fuel tank to prevent gum deposits from forming on these parts and causing possible malfunction of engine. Drain fuel outdoors, into an approved container, away from open flame. Run engine until fuel tank is empty and engine runs out of gasoline.

NOTE: Fuel stabilizer (such as Sta-Bil) is an acceptable alternative in minimizing the formation of fuel gum deposits during storage. Add stabilizer to gasoline in fuel tank or storage container. Always follow mix ratio found on stabilizer container. Run engine at least 10 min. after adding stabilizer to allow it to reach the carburetor.

⚠ CAUTION: Wheels must be chocked or blocked when unit is parked on a slope.

MAINTENANCE



Use only a qualified mechanic for any adjustments, disassembly or any kind of repair .



WARNING: TO AVOID PERSONAL INJURY, ALWAYS TURN MACHINE OFF, MAKE SURE ALL MOVING PARTS COME TO A COMPLETE STOP.



DISCONNECT SPARK PLUG WIRE BEFORE SERVICING UNIT.



RECONNECT SPARK PLUG WIRE, AND ALL GUARDS BEFORE STARTING ENGINE.

Note: Blade, and drive belts are normal wear items. These should be inspected on a regular basis and replaced if worn.

MAINTENANCE HISTORY	
Date of Service	Service Performed

Maintenance Schedule

Follow these hourly maintenance intervals.

Maintenance Operation	Every Use	Every 5 hrs or (Daily)	Every 25 hrs	Every 50 hrs	Every 100-150 hrs
Engine (See Engine Manual)					
Check for excessive vibration		●			
Inspect for loose parts		●			
Inspect for worn/damaged parts	●				
Sharpen Blade			●		
Inspect belts for wear			●		
Replace blade and traction belts					●
Lubricate height adjustment pins			●		
Lubricate front wheels			●		

ENGINE

When servicing engine refer to specific manufacturers engine owner's manual. All engine warranty is covered by the specific engine manufacturer. If your engine requires warranty or other repair work contact your local servicing engine dealer. When contacting a dealer for service it is a good idea to have your engine model number available for reference(See table page 11). If you can not locate a servicing dealer in your area you can contact the manufacturers national service organization.

To reach:
Briggs & Stratton: 800-233-3723

17.1 BLADE REMOVAL / SHARPENING

▲ NOTE: When sharpening the blade it is a good idea to check the balance of the blade. A properly balanced blade will increase life of the bearings and other components.

Tools required: 3/8 inch socket, 5/8 inch socket, torque wrench, blade block.

1. Disconnect spark plug wire.
2. Remove 5 screws (item 76) then remove belt guard (19).
3. Set the unit on its side to allow access to both pulley and the blade.

Note: When tipping the unit on its side, keep the air cleaner side of engine up. Be sure the gas is drained out to prevent from spilling before tipping the unit on its side. Never tip the mower more than 90 degrees and do not leave the mower tipped for any length of time.

4. While protecting your hands with pair of gloves or heavy rag to hold the blade, loosen but do not remove the bolt (88) on the pulley side (fig. 6).

5. Remove jam nut (68), blade washer (43), blade (44), blade washer (43), and blade spacer (39).

6. Replace or sharpen the blade then install in the exact order they were removed (fig. 7).

7. Tighten the jam nut until it is flush with the end of the shaft (fig 7). Then tighten the bolt on the pulley side - Torque it to 80 ft-lbs.

Note: When replacing the blade use B.G.I. Part no. 510107.

8. Reinstall belt guard then connect spark plug.

Note: Before installing the fasteners inspect them for wear and replace as necessary.

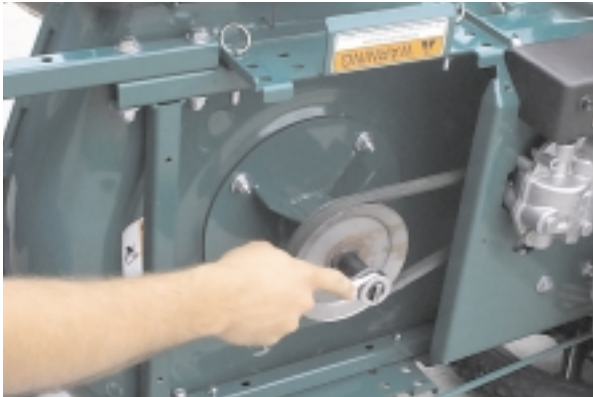

Fig. 6

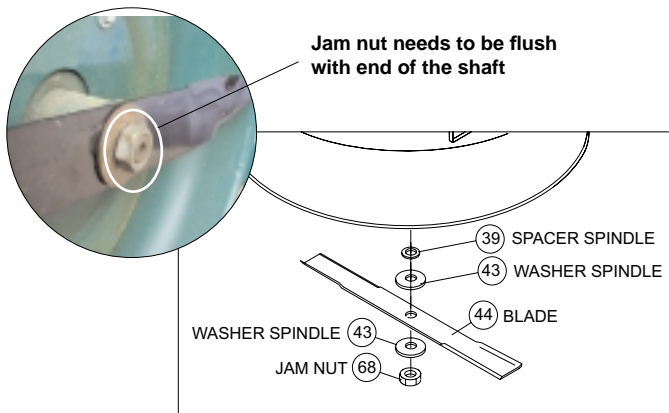

Fig. 7

17.2 BELT REPLACEMENT

When replacing one belt the other should be inspected for wear and replaced if worn. It is good practice to change both belts when either is worn beyond use. Use only original equipment belts for replacement. Billy Goat uses only premium quality, kevlar corded and coated belts in your unit. **Substitute belts do not meet the design and performance requirements for your unit, and will greatly reduce machine performance and belt life.**

Blade Drive Belt

Tools required: 3/8 inch socket, 1/2 inch socket, 3/8" torque wrench.

1. Disconnect spark plug wire.
2. Set the deck height to middle position (3 inches cutting height).
3. Remove 5 screws (item 76) then remove belt guard (19).

4. Loosen but do not remove the nut (71) at the top of the engine base located just front of the engine. This will release the tension on the blade drive belt (37). **NOTE:** It may be necessary to loosen bolt (85) in order to allow idler pulley bracket to pivot.

5. Replace the old belt with the new belt.

Note: Use only O.E.M. approved belt for this machine - B.G.I. Part no. 510139.

6. To adjust tension on the new belt, insert 3/8" torque wrench in the idler bracket, apply 10 lbs. of torque then tighten the nut (71) on top of the engine base (fig. 8).

Note: Belt requires very little tension to drive the blade. Over tensioning the belt will greatly reduce the life of the belt.

7. Install belt guard using 5 screws (76)

8. Reconnect spark plug wire.

Note: Start the unit up and cut grass to make sure the blade belt is not slipping.

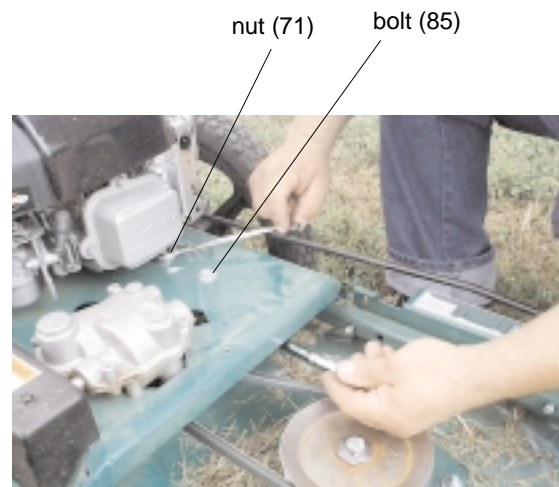

Fig. 8

17.2 BELT REPLACEMENT continued

Drive Belt

Tools required: 3/8 inch socket, 1/2 inch socket, 3/8" torque wrench.

1. Follow steps 1 through 5 above to remove the blade drive belt.
2. Set the unit on its side to allow access to both pulley and the blade.

Note: When tipping the unit on its side, keep the air cleaner side of engine up. Be sure the gas is drained out to prevent from spilling before tipping the unit on its side. Never tip the mower more than 90 degrees and do not leave the mower tipped for any length of time.

3. Swing over the drive belt idler to release tension on drive belt then remove it (fig. 9).

4. Install the new belt (fig. 10).

Note: Use only O.E.M. approved belt for this machine - B.G.I. Part no. 510138.

5. Set the unit back down.

6. Follow steps 6 through 8 on previous section to reinstall the blade belt.



Fig. 9

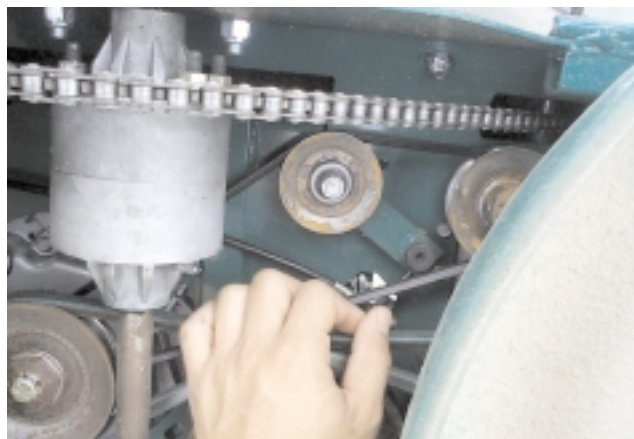

Fig. 10

17.3 SELF PROPELLED DRIVE ADJUSTMENT

Tools required: two 1/2 wrenches.

As the clutch wears, adjustments may be required to maintain proper control cable tension, and clutch engagement (fig. 11). If the clutch begins slipping or squealing during normal operation it may require an adjustment to increase the clutch cable tension. A properly adjusted drive clutch should require a minimum of 3/8" of spring stretch when drive bail is engaged.(fig. 12) Adjust by tightening or by loosening clutch cable adjusting nut as required, located at the underneath the engine base (fig. 13). Replacement of cable may be necessary if adjustment will not allow for proper drive clutch.

⚠ WARNING: *If the drive clutch begins to squeal or slip, do not continue to operate your unit until adequate adjustment or repair has been performed. Improper adjustment can cause drive clutch to slip and overheat, greatly reducing machine performance and transmission life.*



Fig. 11

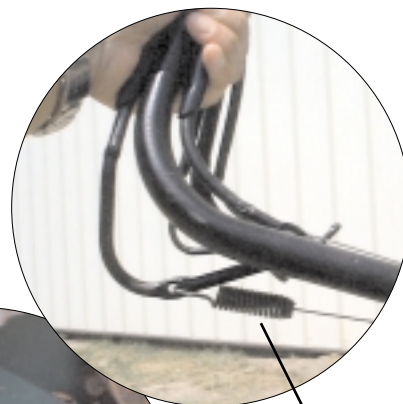

Fig. 12

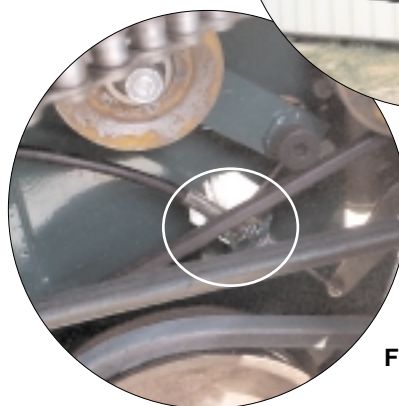
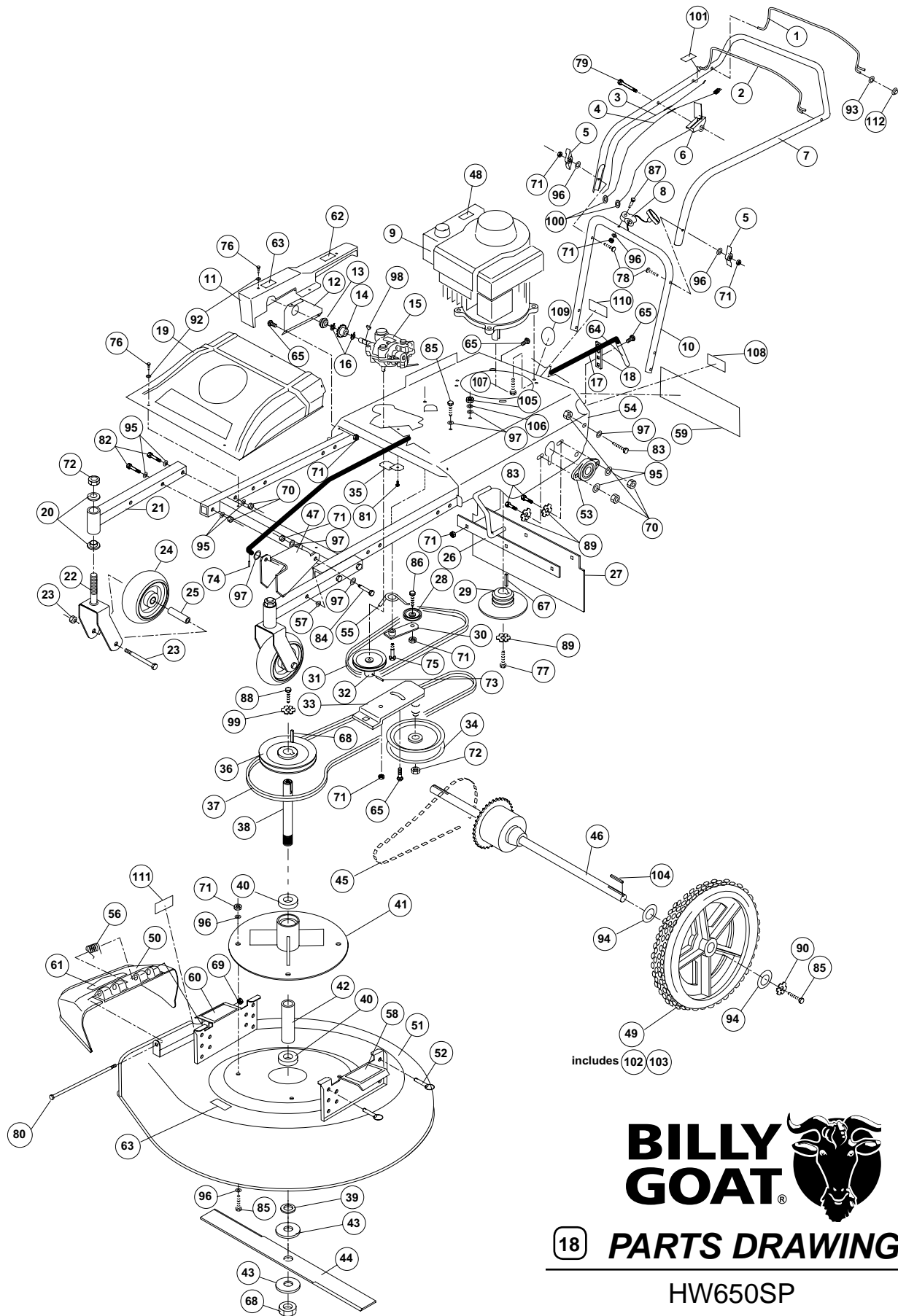

Fig. 13

3/8" stretch
when engaged



18 PARTS DRAWING

HW650SP

19 PARTS LIST

Item No.	Description	HW650SP Part No.	Qty	Item No.	Description	HW650SP Part No.	Qty
1	ROD BAIL DRIVE WA	510178	1	58	LABEL CUTTING HGT.	510147	1
2	ROD BAIL ENGINE WA	510179	1	59	LABEL INSTRUCTION	510207	1
3	CABLE ENGINE BRAKE	510134	1	60	LABEL WARNING MOWER	510206	1
4	CABLE CLUTCH DRIVE HW	510135	1	61	LABEL OPEI	400424	1
5	KNOB WING 5/16" NC BLACK	890108	2	62	LABEL OIL CHAIN	830502	1
6	CONTROL SHIFT 3 SPEED	510127	1	63	LABEL DANGER GUARDS	900327	2
7	HANDLE UPPER HW	510106	1	64	GRIP RED 5/16"	900937	1
8	GUIDE ROPE	830533	2	65	CARRIAGE BOLT 5/16"-18 X 1	8024040	8
9	ENGINE 6.5 HP B&S INTEK	510152	1	66	KEY SQ. 3/16 x 5/8"	9201072	1
10	HANDLE LOWER HW	510112	1	67	KEY SQ. 3/16 x 1 1/4"	9201071	1
11	GUARD CHAIN HW	510111	1	68	NUT JAM 7/8" - 14	350155	1
12	PLATE BEARING RIGHT	510120	1	69	NUT LOCK 1/4-20 HEX ZP	8160001	1
13	BEARING 1/2 CLIP	510125	2	70	NUT LOCK 3/8-16	8160003	13
14	8 TOOTH SPROCKET	510126	1	71	NUT LOCK 5/16	8160002	17
15	TRANSMISSION 3 SP	510108	1	72	NUT LOCK 5/8 - 11	8160007	3
16	C-CLIP 1/2"	350146	2	73	ROLL PIN 3/16 X 1.25	8195166	1
17	ROD CASTER LOCK HW	510140	1	74	PIN COTTER 1/8" x 1"	8197031	1
18	PLATE CASTER LOCK	510204	1	75	BOLT SHOULDER 1/2" x 1"	500114	1
19	GUARD BELT HW	510110	1	76	SCREW SELF TAP 1/4 x 3/4"	510208	8
20	BUSHING PLASTIC 0.625 ID	510185	4	77	SCREW CAP 3/8-24 x 1 1/4"	400946	1
21	TUBE CASTER WA	510186	2	78	SCREW CURVE HEAD 5/16	900547	2
22	BRACKET CASTER WA	510187	2	79	SCREW CAP 1/4-20 x 2"	8041010	1
23	AXLE BOLT W/ZERK AND NUT	510148	2	80	SCREW CAP 1/4-20 x 7" ZP	8041023	1
24	WHEEL FRONT 6"	510133	2	81	SCREW SELF TAP 6 x 16	510188	3
25	SPANNER BUSHING W/ HOLE	510149	2	82	SCREW CAP 3/8"-16X2 3/4"	8041057	4
26	PLATE DEFLECTOR MOUNT	510144	1	83	SCREW CAP 3/8"-16 X 1 1/2"	8041052	8
27	RUBBER DEFLECTOR	510141	1	84	BOLT SHOULDER 5/16 X 1 3/4"	350179	1
28	PULLEY V IDLER 2.5	510137	1	85	SCREW CAP 5/16-18 x 1"	8041028	7
29	PULLEY DOUBLE 2 1/4" W/ INERTIA	510237	1	86	SCREW CAP 5/16-18 x 1 3/4"	8041030	3
30	ARM IDLER TRANS WA HW	510199	1	87	SCREW CAP 5/16-18 x 2"	8041032	2
31	BELT 3L320	510138	1	88	SCREW CAP 7/16-20 X 1 GR. 8	510213	1
32	PULLEY 3" OD 10MM BORE	510122	1	89	TWISTED WASHER 3/8"	400502	5
33	PLATE ENGINE IDLER WA HW	510191	1	90	TWISTED WASHER 5/16"	430298	2
34	PULLEY IDLER	510136	1	91	TY WRAP	900407	4
35	BRACKET TRANS LEVER	510123	1	92	WASHER 1/4 SAE BLACK	510193	8
36	PULLEY 5.5" OD x 7/8" BORE	510118	1	93	WASHER 1/4 FC	8171002	3
37	BELT BLADE 5L560	510139	1	94	WASHER 3/4 SAE	8172015	4
38	SHAFT DRIVE BLADE	510114	1	95	WASHER 3/8 FC	8171004	12
39	SPACER SPINDLE BC2401	500232	1	96	WASHER 5/16 FC	8171003	14
40	BEARING 7/8" ID SEALED	500101	2	97	WASHER 5/16 SAE	8172008	5
41	SPINDLE BLADE WA HW	510105	1	98	KEY WOODRUFF 1/8" X 1/2	510180	1
42	TUBE SPACER SPINDLE	510116	1	99	WASHER LOCK 7/16 TWIST	850132	1
43	WASHER SPINDLE 2,5 OD	510117	2	100	RUBBER GROMMET	510169	2
44	BLADE 23 1/2 W 7/8 HOLE	510107	1	101	LABEL DRIVE/BLADE	510174	1
45	CHAIN #41 75 PITCH	510132	1	102	TIRE 16" HEAVY DUTY HW	510239	2
46	REAR AXLE ASSY	510104	1	103	INNER TUBE 16" HW	510240	2
47	BRACKET CASTER LOCK	510194	1	104	KEY SQ. 3/16 x 2 1/8"	9201087	2
48	LABEL DO NOT FILL	400268	1	105	NUT JAM 5/16-18	8142002	1
49	WHEEL & TIRE 16" (incl. 102 & 104)	510145	2	106	WASHER LOCK 5/16	8177011	1
50	GUARD EXHAUST CHUTE	510197	1	107	SCREW 3/8 X 1 1/2" TAPTITE	890408	3
51	DECK ASSY W/LABELS	510160	1	108	LABEL PATENT PENDING	500183	1
52	PIN 3/8 X 1 1/2	510130	4	109	LABEL READ MANUAL	890301	1
53	BEARING 3/4 CAST FLANGE	510195	2	110	LABEL EAR EYE BREATHING	890254	1
54	BASE ASSY W/LABELS	510161	1	111	LABEL FLYING DEBRIS	810736	1
55	SPRING TRANS IDLER	510142	1	112	NUT PAL 5/16"	360203	2
56	SPRING EXHAUST CHUTE	510205	1				
57	BUSHING LEVER CONTROL	500152	2				

NOTE: For repairs beyond the minor adjustments listed below, contact your nearest authorized service dealer.



Problem	Possible Cause	Solution
The engine will not start	<ol style="list-style-type: none"> 1. Operator presence control bail is not engaged. 2. Engine not properly primed. 3. Out of gasoline or bad or old gasoline. 4. Spark plug wire disconnected. 5. Dirty air cleaner. 6. Blade is trying to cut grass while starting. 	<ol style="list-style-type: none"> 1. Engaged operator presence control bail. 2. Prime to choke. 3. Check gasoline. 4. Check for spark with an approved tester. 5. Clean or replace air cleaner. 6. Start the mower on the pavement or previously cut area.
The engine will not stop	<ol style="list-style-type: none"> 1. Damaged operator presence control bail. 2. Damaged control cable. 	<ol style="list-style-type: none"> 1. Replace operator presence control bail. 2. Replace control cable.
Engine runs poorly	<ol style="list-style-type: none"> 1. Spark plug wire loose. 2. Engine RPM set too low. 3. Carburetor out of adjustment. 4. Water or dirt in fuel system. 5. Spark plug fouled, faulty or wrong gap. 	<ol style="list-style-type: none"> 1. Sharpen or replace blade (see page 8). 2. Check engine RPM.(refer to engine manual). 3. Adjust carburetor (refer to engine manual). 4. Drain or siphon then replace with fresh gasoline. 5. Reset gap or replace spark plug (refer to engine manual).
Will not cut or has poor cutting performance.	<ol style="list-style-type: none"> 1. Dull or bent Blade. 2. Clogged deck. 3. Engine running at too low RPM. 4. Wet grass. 5. Excessively high grass. 	<ol style="list-style-type: none"> 1. Sharpen blade or replace blade (see page 8). 2. Unclog deck (see page 5). 3. Check engine RPM (refer to engine manual). 4. Do not mow when grass is wet; wait until later to cut. 5. Mow once at a high cutting height then mow again at desired height or make a narrower cutting path.
Uneven cut	<ol style="list-style-type: none"> 1. Height adjust is not set correctly. 2. Dull or bent blade. 	<ol style="list-style-type: none"> 1. Be sure height adjust is set the same on both sides (see page 5). 2. Sharpen blade or replace blade (see page 8).
Abnormal vibration.	<ol style="list-style-type: none"> 1. Loose or out of balance blade. 2. Bent blade. 3. Loose engine. 	<ol style="list-style-type: none"> 1. Check blade mount and balance or replace if required. 2. Replace with the new blade (see page 8). 3. Check Engine mount.
Belt slips or smokes.	<ol style="list-style-type: none"> 1. Belt tension too low. 2. Belt worn or stretched. 3. Pulleys worn or damaged. 	<ol style="list-style-type: none"> 1. Increase tension at idler(see page 8). 2. Replace belt. 3. Replace pulleys
No self propelling.	<ol style="list-style-type: none"> 1. Not set to gear. 2. Out of adjustment clutch cable. 3. Broken clutch cable. 4. Worn or broken belt. 	<ol style="list-style-type: none"> 1. Shift lever in desired gear 2. Adjust clutch cable (see page 9). 3. Replace with new cable. 4. Replace belt (see page 9).
Self propelled drive will not release .	<ol style="list-style-type: none"> 1. Clutch cable out of adjustment. 2. Damaged operator presence control bail. 	<ol style="list-style-type: none"> 1. Adjust clutch cable (see page 9). 2. Replace operator presence control bail.
Engine is locked, will not pull over.	<ol style="list-style-type: none"> 1. Debris locked against blade. 2. Operator presence control bail is not engaged. 3. Broken control cable 	<ol style="list-style-type: none"> 1. Remove debris (see page 5). 2. Engaged operator presence control bail. page 10) 3. Replace control cable.

22.1

Engine Service and Warranty
Contact your nearest engine manufacturer's authorized servicing dealer.

21

Serial Plate Record your machine model, serial number and date-of-purchase and where purchased

	1803 S.W. Jefferson Lee's Summit, MO 64082 / USA Tel (816) 524-9666 Fax (816) 524-6983		
			
97	Model <input type="text"/>	Serial No. <input type="text"/>	
	Unit(Weight) <input type="text"/> lbs. <input type="text"/> kg	Engine Power <input type="text"/> kW <input type="text"/> rpm	
MEETS ALL CPSC REQUIREMENTS			

Purchase Date _____ Purchased from _____

22

WARRANTY PROCEDURE

Should a Billy Goat Machine fail due to a defect in material and / or workmanship, the owner should make a warranty claim as follows:

- The Machine must be taken to the dealer from whom it was purchased or to an authorized Servicing Billy Goat Dealer.
- The owner must present the remaining half of the Warranty Registration Card, or, if this is not available, the invoice or receipt.
- The Warranty Claim will be completed by the authorized Billy Goat Dealer and submitted to their respective Billy Goat Distributor for their territory. Attention: Service Manager. Any parts replaced under warranty must be tagged and retained for 90 days.
- The distributor service manager will sign off on the claim and submit it to Billy Goat for consideration.
- The Technical Service Department at Billy Goat will study the claim and may request parts to be returned for examination. Billy Goat will notify their conclusions to the distributor service manager from whom the claim was received.
- The decision by the Quality / Service department at Billy Goat to approve or reject a Warranty claim is final and binding.

Note: To process a Warranty Claim, it is necessary to quote the Model & Serial Number which are printed on the Billy Goat Serial Plate (See owner's manual).



BILLY GOAT INDUSTRIES INC.
 PO BOX 308 LEE'S SUMMIT, MO 64063-0308 / USA
 PHONE: 816-524-9666 FAX: 816-524-6983 www.billygoat.com