

2

## OPTIONAL ACCESSORIES

## INTAKE

**HOSE KIT TR P/N 810509** Standard on TR units. [8"(203mm) x 12.5' (3.8m)]

**HOSE KIT HTR P/N 810896** Standard on HTR units. [10"(254mm) x 12.5' (3.8m)]

**HOSE COUPLER KIT 8" (203mm) TR P/N 810525** Quick release coupler joins 2 hoses together to increase vacuuming distance and allows hoses to be separated for storage.

**HOSE CONNECTOR KIT 8" (203mm) TR P/N 810524**  
**HOSE CONNECTOR KIT 10" (254mm) HTR P/N 810776**  
 For permanently connecting 2 hoses together to increase vacuuming distance .

## EXHAUST

## ALL MODELS

**EXHAUST EXTENSION KIT P/N 810637**  
 Increases exhaust height 11"(280mm) for loading debris into elevated locations.

**EXHAUST HOSE KIT P/N 810508**  
 [7"(178mm) x 12.5' (3.8m)] Quick release coupler and hose increases exhaust distance.

**EXHAUST HOSE COUPLER KIT P/N 810506**  
 [7"(178mm)] Quick release coupler joins 2 hoses together to increase vacuuming distance and allows hoses to be separated for storage.

**EXHAUST HOSE CONNECTOR KIT P/N 810510** [7"(178mm)] Permanently joins 2 exhaust hoses together to increase exhaust distance.

**PANEL FILTER KIT P/N 810584** Provides air filter panel for use on truck and trailer mounted debris enclosures.

**PORTABLE DEBRIS BAG P/N 810660**  
 1.3 yds.<sup>3</sup> (1.0m<sup>3</sup>) or 28.4 bushels (1000L).  
 For portable use. Several bags can be filled and left for later pickup.

1

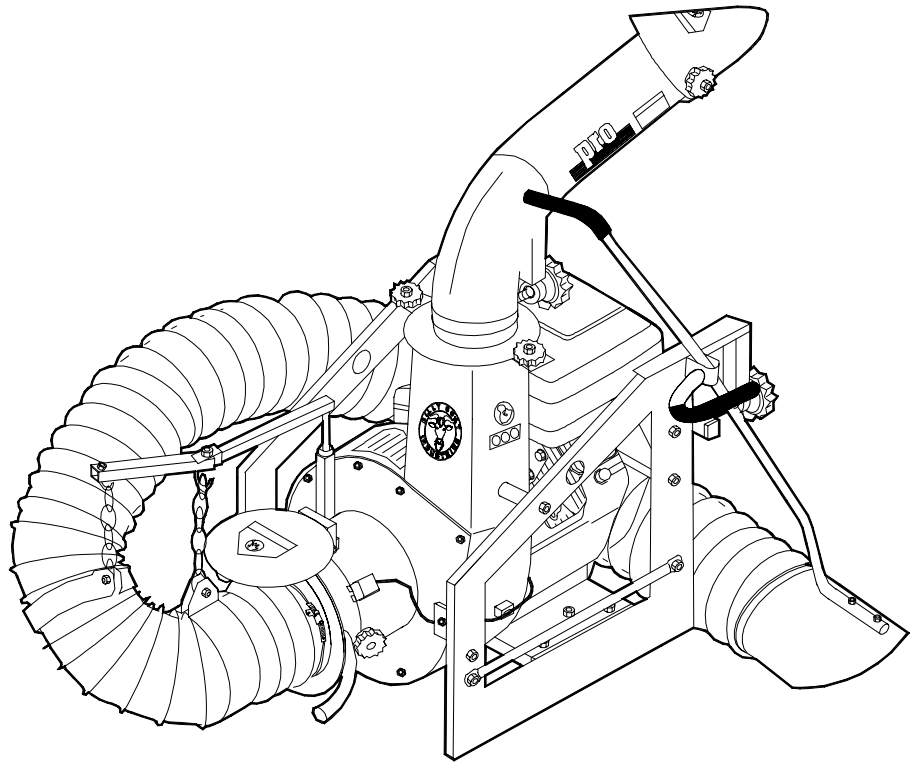

*Thank You for Selecting*  
**The Powerful TRUCK LOADER VACUUM**

# Operator Owner's Manual

**HTR1601V, TR1303H, TR1103**

3

## Specifications

	HTR1601V		TR1303H		TR1103	
<b>ENGINE: H.P.</b>	16 H.P. TWIN OHV VANGUARD GUARD		13.0 HP (10.68 kW)		11.0 HP (9.04 kW)	
<b>ENGINE: WEIGHT</b>	79 lbs. (35.83 kg)		68.4 lbs. (31 kg)		64.25 lbs. (29.1 kg)	
<b>ENGINE: TYPE</b>	Briggs & Stratton 4 Cycle IC Twin		HONDA 4 cycle		B & S 4 cycle IP	
<b>ENGINE: FUEL CAPACITY</b>	9 qt. (8.52 L), Float feed carb. & fuel pump		6.9 qt. (6.0 L)		6.0 qt. (5.7 L)	
<b>ENGINE: OIL CAPACITY</b>	1.75 qt. (1.66 L), Oil pump w/filter		1.16 qt. (1.1 L)		1.5 qt. (1.42 L)	
	<b>UNT</b>	<b>SHIP</b>	<b>UNT</b>	<b>SHIP</b>	<b>UNT</b>	<b>SHIP</b>
<b>UNIT &amp; NOZZLE WEIGHT:</b>	247 lb (112 kg)	268 lb (121.6 kg)	214.2 lb (97.2 kg)	223.2 lb (101.2 kg)	210 lb (95 kg)	230 lb (104 kg)
<b>HOSE WEIGHT:</b>	27 lb (112.2 kg)	31 lb (14.1 kg)	14 lb (6 kg)	23 lb (10 kg)	14 lb (6 kg)	23 lb (10 kg)
<b>TOTAL WEIGHT (2 cartons):</b>	274 lb (124.3 kg)	299 lb (135.6 kg)	228.2 lb (103.5 kg)	257.2 lb (116.7 kg)	224 lb (102 kg)	253 lb (115.0 kg)

UNIT SIZE: OVERALL LENGTH: HTR 36.5"(0.93m) / TR 35"(0.89M) OVERALL WIDTH: 24.25" (0.62m) OVERALL HEIGHT: 44" (1.12m)

# IN THE INTEREST OF SAFETY



**BEFORE STARTING ENGINE, READ AND UNDERSTAND THE "ENTIRE OPERATOR'S MANUAL & ENGINE MANUAL."**



**THIS SYMBOL MEANS WARNING OR CAUTION. DEATH, PERSONAL INJURY AND/OR PROPERTY DAMAGE MAY OCCUR UNLESS INSTRUCTIONS ARE FOLLOWED CAREFULLY.**



## WARNING!

The engine exhaust from this product contains chemicals known to the State of California to cause cancer, birth defects or other reproductive harm.

## WARNING: DO NOT



1. **DO NOT** run engine in an enclosed area. Exhaust gases contain carbon monoxide, an odorless and deadly poison.

2. **DO NOT** place hands or feet near moving or rotating parts.

3. **DO NOT** store, spill or use gasoline near an open flame, or devices such as a stove, furnace, or water heater which use a pilot light or devices which can create a spark.

4. **DO NOT** refuel indoors where area is not well ventilated. Outdoor refueling is recommended.

5. **DO NOT** fill fuel tank while engine is running. Allow engine to cool for 2 minutes before refueling. Store fuel in approved safety containers.

6. **DO NOT** remove fuel tank cap while engine is running.

7. **DO NOT** operate engine when smell of gasoline is present or other explosive conditions exist.

8. **DO NOT** operate engine if gasoline is spilled. Move machine away from the spill and avoid creating any ignition until the gasoline has evaporated.

9. **DO NOT** transport unit with fuel in tank.

10. **DO NOT** smoke when filling fuel tank.

11. **DO NOT** choke carburetor to stop engine. Whenever possible, gradually reduce engine speed before stopping.

12. **DO NOT** run engine at excessive speeds. This may result in injury & /or damage to unit.

13. **DO NOT** tamper with governor springs, governor links or other parts which may change the governed engine speed.

14. **DO NOT** tamper with the engine speed selected by the engine manufacturer.

15. **DO NOT** check for spark with spark plug or spark plug wire removed. Use an approved tester.

16. **DO NOT** crank engine with spark plug removed. If engine is flooded, place throttle in "FAST" position and crank until engine starts.

17. **DO NOT** strike flywheel with a hard object or metal tool as this may cause flywheel to shatter in operation. Use proper tools to service engine.

18. **DO NOT** operate engine without a muffler. Inspect periodically and replace, if necessary. If engine is equipped with muffler deflector, inspect periodically and replace, if necessary, with correct deflector.

19. **DO NOT** operate engine with an accumulation of grass, leaves, dirt or other combustible material in the muffler area.

20. **DO NOT** use this engine on any forest covered, brush covered, or grass covered unimproved land unless a spark arrester is installed on the muffler. The arrester must be maintained in effective working order by the operator. In the State of California the above is required by law (Section 4442 of the California Public Resources Code). Other states may have similar laws. Federal laws apply on federal lands.

21. **DO NOT** touch hot muffler, cylinder, or fins because contact may cause burns.

22. **DO NOT** run engine without air cleaner or air cleaner cover.

23. **DO NOT** operate during excessive vibration!

24. **DO NOT** leave machine unattended while in operation.

25. **DO NOT** park machine on a steep grade or slope.

## WARNING: DO



1. **ALWAYS DO** remove the wire from the spark plug when servicing the engine or equipment TO PREVENT ACCIDENTAL STARTING.

2. **DO** keep cylinder fins and governor parts free of grass and other debris which can affect engine speed.

3. **DO** pull starter cord slowly until resistance is felt. Then pull cord rapidly to avoid kickback and prevent hand or arm injury.

4. **DO** examine muffler periodically to be sure it is functioning effectively. A worn or leaking muffler should be repaired or replaced as necessary.

5. **DO** use fresh gasoline. Stale fuel can gum carburetor and cause leakage.

6. **DO** check fuel lines and fittings frequently for cracks or leaks. Replace if necessary

7. **Follow** engine manufacturer operating and maintenance instructions.

8. **Inspect** machine and work area before starting unit.

## 6 TABLE OF CONTENTS

SAFETY INSTRUCTIONS	2
GENERAL SAFETY	3
ASSEMBLY	3
PARTS BAG & CONTROLS	4
LABELS	4
OPERATION	5 - 7
MAINTENANCE	8 - 9
PARTS DRAWING & LIST	10 - 12
TROUBLESHOOTING	12
WARRANTY	12

## 7

### SOUND

Sound tests conducted were in accordance with 2000/14/EEC and were performed on 2/21/2002 under the conditions listed:

**NOTE:** Sound power level listed is the highest value for any model in this manual. Please refer to serial plate on the unit for the sound power level for your model.

Sound level of 104 dBA at operator position



**120 dB**

(HTR1601VN MODEL)

GENERAL CONDITION:	Sunny
TEMPERATURE:	45° F (7.2° C)
WIND SPEED:	5 MPH (8.1 kmh)
WIND DIRECTION:	South West
HUMIDITY:	60 %
BAROMETRIC PRESSURE:	30.18" Hg (767mm Hg)

## 8

### VIBRATION

VIBRATION LEVEL 0.02g

Vibration levels at the operators handles were measured in the vertical, lateral, and longitudinal directions using calibrated vibration test equipment. Tests were performed on 07/14/94 under the conditions listed:



GENERAL CONDITION:	Sunny
TEMPERATURE:	78° F (23.8° C)
WIND SPEED:	16 MPH (25.7 kmh)
WIND DIRECTION:	South East
HUMIDITY:	62 %
BAROMETRIC PRESSURE:	30.10" Hg (765mm Hg)

# GENERAL SAFETY

*For your safety and the safety of others, these directions should be followed:*

 **Do not operate this machine without first reading owner's manual and engine manufacturer's manual.**

  **Use of Ear Protection is recommended while operating this machine.**

  **Use of Eye and Breathing protection is recommended when using this machine, especially in dry and dusty conditions. Optional bag cover directs dust toward ground, away from the operator.**

**DO NOT** place hands or feet inside nozzle intake opening, near debris outlet or near any moving parts.

**DO NOT** start engine without hose and exhaust elbow connected firmly in place to housing and exhaust outlet.

**DO NOT** operate without discharging exhaust into enclosed container.

**DO NOT** operate during excessive vibration.

**DO NOT** remove hose until engine has been turned off and has come to a complete stop.

**DO NOT** operate machine with hose or exhaust elbow removed.

**DO NOT** use this machine for vacuuming **exclusively** sand, dust, fine dirt, rock, glass, string like material, grain, rags, cans, metal, bark or water.

**DO NOT** operate this machine on slopes greater than 20%.

**DO NOT** pick up any hot or burning debris, or any toxic or explosive material.

**DO NOT** allow children to operate this equipment.

## 10 ASSEMBLY



**Read all safety and operating instructions before assembling or starting this unit.**



**PUT OIL IN ENGINE BEFORE STARTING.**

Your Billy Goat is shipped from the factory in two cartons and is completely assembled except for the exhaust elbow, exhaust flapper, nozzle, handle loop for nozzle, hose booms, hose bands, hose coupler, hose clamps and related hardware. The hose is packaged in a separate carton..

1. **ASSEMBLE** exhaust elbow (item 10), to main unit and firmly tighten knobs (item 13), that are preassembled to main unit.

2. **ASSEMBLE** flapper (item 8), to exhaust elbow (item 10), using carriage bolt (item 9), knob (item 7), washers (item 6) and lock washers (item 11).

3. **SECURELY ATTACH** unit to tailgate of a truck or to a trailer, so that the exhaust discharges into an enclosed container.

4. **ATTACH** hose to hose coupler (item 59), using hose clamp (item 60)

*NOTE: This unit is equipped with a unidirectional hose. Assemble hose so that interior hose material seams face toward unit.*

5. **ASSEMBLE** hose to housing of main unit and securely tighten knob (item 13), that is preassembled to housing front plate.

6. **ASSEMBLE** handle loop nozzle (item 82), to nozzle handle using screw cap (item 80), washer (item 6) and lock nut (item 5). Adjust handle loop to desired height and angle and securely tighten in place.

7. **ASSEMBLE** nozzle handle (item 78), to nozzle (item 77), using screws (item 80), washers (item 79), washers (item 4) and lock nuts (item 5).

8. **ATTACH** assembled nozzle to hose using hose clamp (item 60). Before tightening hose clamp, position nozzle handle upward when hose is stretched to prevent twisting load on hose assembly during operation.

9. **ASSEMBLE** tube square boom (item 51), to boom pivot (item 50), using chain loop assembly (item 54), washers (item 4) and lock nut (item 52).

10. **ASSEMBLE** remaining chain loop assembly (item 54), to end of tube square boom (item 51) using washer (item 4) and lock nut (item 52).

11. **SLIDE** boom assembly into square tube on front of housing.

12. **ASSEMBLE** hose bands (item 56) around hose and onto chain loop assemblies on boom assembly using screws (item 55) and lock nuts (item 52) (see ADJUSTING HOSE BOOM on page 5).

## 11 PACKING CHECKLIST

### TR MODELS

Briggs & Stratton 11 HP

Honda 13 HP

Engine Manual Per Model

### HTR MODELS

Briggs & Stratton  
Vanguard-Twin 16 HP

Handle Loop Nozzle 811019

Parts Bag & Literature Assy 811065 HTR & TR

Parts Bag & Literature Assy

These items should be included in your carton. If any of these parts are missing, contact your dealer.

### Boxing Checklist

Check

- Exhaust Elbow 811109
- Boom Square Arm 810875
- Boom Pivot WA 810870
- \_\_\_\_\_ Per Model \_\_\_\_\_
- Band Hose Boom 8" (203mm) TR 810880 Qty. 2
- Band Hose Boom 10" (254mm) HTR 810868 Qty. 2
- \_\_\_\_\_ Per Model \_\_\_\_\_
- Coupler Weld Assy. 8" (203mm) TR 811116
- Coupler Weld Assy. 10" (254mm) HTR 811115
- \_\_\_\_\_ Per Model \_\_\_\_\_
- Hose Clamps 8" (203mm) TR 810566 Qty. 2
- Hose Clamps 10" (254mm) HTR 810706 Qty. 2
- Handle Nozzle 811020 TR and HTR
- \_\_\_\_\_ Per Model \_\_\_\_\_
- Nozzle 8" (203mm) TR 811007
- Nozzle 10" (254mm) HTR 811005
- \_\_\_\_\_ Per Model (separate carton) \_\_\_\_\_
- Hose 8" x 12.5' TR 810523
- Hose 10" x 12.5' HTR 810705

**12 PARTS BAG & LITERATURE ASSY P/N 811128**

**13 CONTROLS**

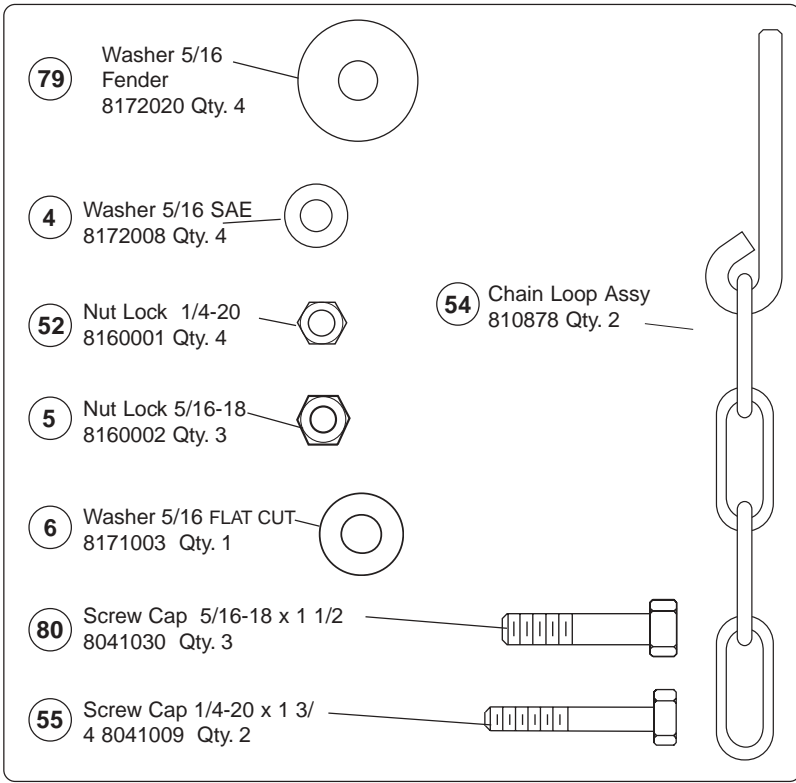

Literature Checklist	
Owner's Manual	Check <input type="checkbox"/> Owner's Manual 811126
Literature Parts Bag	Check <input type="checkbox"/> Literature Parts Bag 811127
Literature HTR / TR Accessories	Check <input type="checkbox"/> Literature HTR / TR Accessories 811017
Warranty Card	Check <input type="checkbox"/> Warranty Card 400972
EU Declaration of Conformity & EU Distributor List	Check <input type="checkbox"/> EU Declaration of Conformity & EU Distributor List 811018

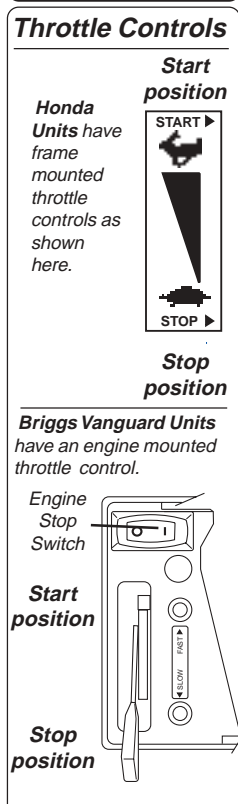

**14 INSTRUCTION LABELS**

**15 ENGINE LABELS**

These labels should be included on your Vacuum. If any of these labels are damaged, replace them before putting this equipment into operation. Item and part numbers are given to help in ordering replacement labels..



Label Do Not Fill While Engine Is Hot  
Item 81 Part No.400268



Label Danger Keep Hands and Feet Away  
Item 3 Part No.400424



Label Caution  
Item 47 Part No.830138



Label Danger Flying Material  
Item No. 19 Part No. 810736



Label Ear Eye Breathing  
Item No. 48 Part No. 890254



Label Read Owner's Manual  
Item 15 Part No.830301

**Briggs & Stratton Vanguard**

**ENGINE MAINTENANCE**

1. CHECK OIL LEVEL	8 HOURS
2. CHECK & CLEAN AIR CLEANER	25 HOURS
3. CHANGE OIL	50 HOURS
4. REPLACE OIL FILTER	100 HOURS
5. CLEAN COOLING FINS	100 HOURS

See Operating and Maintenance Instructions

**Honda**

**OIL ALERT**

WHEN OIL LEVEL LOW, ENGINE STOPS IMMEDIATELY.

HONDA MOTOR CO., LTD. MADE IN JAPAN

**Briggs & Stratton**

**THIS ENGINE EQUIPPED WITH LOW OIL SENSOR, IF ENGINE WILL NOT START, CHECK OIL LEVEL**



# OPERATION

**INTENDED USE:** This machine is designed for vacuuming leaves, grass clippings and other types of organic litter. Debris mixed with cans, bottles and small amounts of sand can be vacuumed; however, it is not this machine's primary purpose. Vacuuming cans, bottles and sand will affect the longevity of your machine.

Do not operate if excessive vibration occurs. If excessive vibration occurs, shut engine off immediately and check for damaged or worn impeller, loose impeller bolt, loose impeller key, loose engine or lodged foreign objects. Note: See parts list for proper impeller bolt torque specifications. (See trouble shooting section on page 12).



Like all mechanical tools, reasonable care must be used when operating machine.

**Inspect machine work area and machine before operating. Make sure that all operators of this equipment are trained in general machine use and safety.**



**PUT OIL IN ENGINE BEFORE STARTING.**

## 16.1 STARTING

**SECURE LOADER TO TAILGATE OR MOUNTING:**



**ENGINE:** See engine manufacturer's instructions for type and amount of oil and gasoline used. Engine must be level when checking and filling oil and gasoline.

**ENGINE SPEED:** Controlled by throttle lever on the frame (16HP Twin on engine). Under normal conditions, operate at minimum throttle to accomplish your current cleaning task.

**FUEL VALVE:** Move fuel valve to "ON" position (when provided on engine).

**INTAKE HOSE:** Must be attached to front plate to start engine.

**CHOKE:** Located on engine near engine throttle panel.

**STOP SWITCH:** Move to on position (when provided).

**THROTTLE:** Move remote throttle control to fast position. Pull starting rope to start engine.

**IF YOUR UNIT FAILS TO START:**

See Troubleshooting on page 12.

## 16.2 VACUUMING OPERATION

**EXHAUST FLAPPER:** Discharging into enclosed container, position exhaust flapper to desired opening and secure adjustment knob before starting engine. NOTE: An enclosed container must capture all debris delivered into it preventing any debris from blowing back onto unit's engine (see page 1 optional accessories).

**NOZZLE:** With machine running and fully assembled, move nozzle in sweeping motions over debris. For maximum pickup, move nozzle close to debris, but without blocking air flow into the nozzle (see figure 1). **NOTE:** Never bury nozzle into debris.

## 16.6 HOSE OPERATION TIPS

**THE HOSE IS A REPLACEABLE WEAR ITEM.**

**FOR BEST HOSE OPERATION RESULTS, FOLLOW THESE RECOMMENDATIONS.**

Keep hose as straight as possible during operation for best pick-up and to avoid clogs. Avoid sharp bends in hose which will reduce efficiency and may promote clogs.

**NEVER DRAG HOSE.** Always remove and store hose before transporting unit.

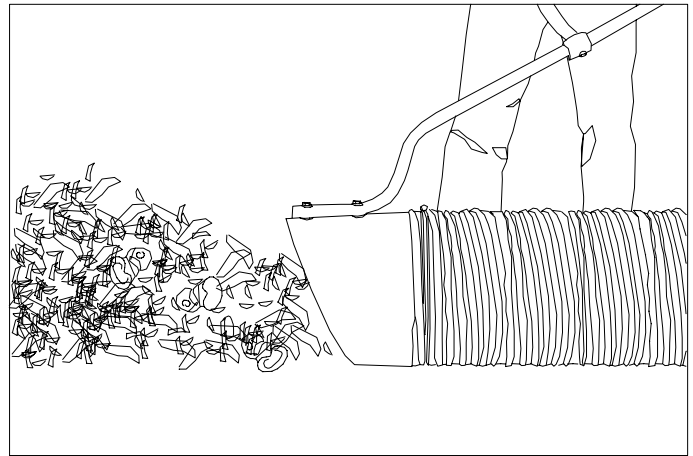

fig. 1

## ADJUSTING HOSE BOOM:

Properly adjusting the boom will prevent most hose clogs from occurring and will give optimum vacuum performance by keeping hose straight next to housing (see fig. 2).

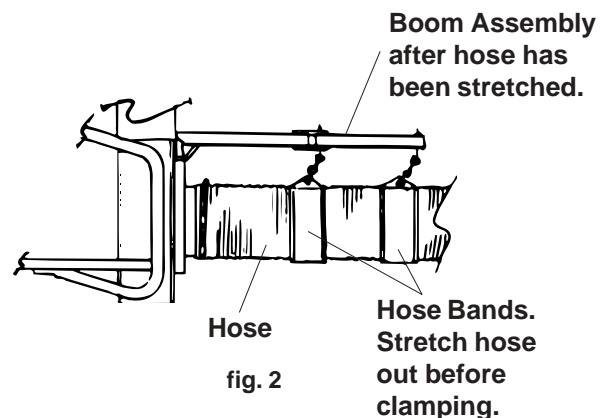

fig. 2

**UNCLOGGING A CLOGGED HOSE:**

With engine running and unit secured to tailgate, fully stretch hose in a straight line to dislodge the clog. If the clog will not clear, turn unit off, and allow engine to come to a complete stop. Remove hose and manually clear hose clog.

**UNCLOGGING A CLOGGED HOUSING OR EXHAUST ELBOW:**

Turn engine off and wait for impeller to come to a complete stop. Disconnect spark plug wire.

**Danger**, the clog may contain sharp materials.



Wearing durable gloves, clear the clog.

Reconnect spark plug wire.

**HOSE LIFE:**

To increase hose life, periodically rotate hose and reposition nozzle and coupler on front plate of unit. This increases hose life by keeping hose from wearing only on one side.

**HEAVY DEBRIS REMOVAL**

**TILT NOZZLE FORWARD TO PICK UP DIFFICULT DEBRIS.**

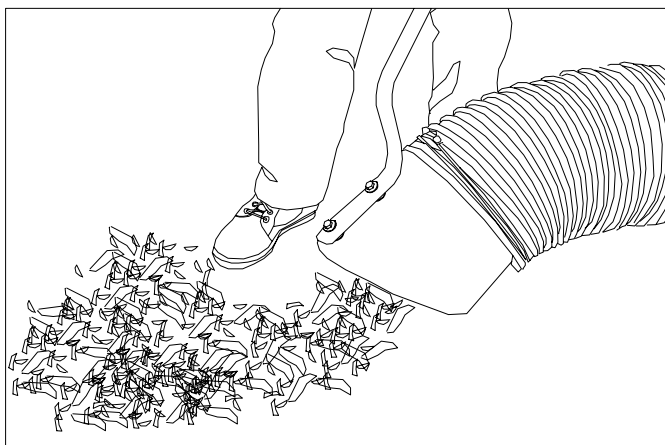

## 16.4

## HANDLING &amp; TRANSPORTING:

**ALWAYS REMOVE LOADER FROM TAILGATE OR MOUNTING BEFORE TRANSPORTING OR OPENING TAILGATE.**

Using two people to lift machine is recommended. Lift holding the rear handle and front of frame. Secure in place during transport.

**HOSE: DO NOT** drag the hose with vehicle.

## 16.5

## STORAGE

Turn fuel supply off when unit is not in use.

 Never store engine indoors or in enclosed poorly ventilated areas with fuel in tank, where fuel fumes may reach an open flame, spark or pilot light, as on a furnace, water heater, clothes dryer or other gas appliance.

**If engine is to be unused for 30 days or more, prepare as follows:**

 Be sure engine is cool. Do not smoke. Remove all gasoline from carburetor and fuel tank to prevent gum deposits from forming on these parts and causing possible malfunction of engine. Drain fuel outdoors, into an approved container, away from open flame. Run engine until fuel tank is empty and engine runs out of gasoline.

**NOTE:** Fuel stabilizer (such as Sta-Bil) is an acceptable alternative in minimizing the formation of fuel gum deposits during storage. Add stabilizer to gasoline in fuel tank or storage container. Always follow mix ratio found on stabilizer container. Run engine at least 10 min. after adding stabilizer to allow it to reach the carburetor.

 **HOSE STORAGE:** Storing hose in a covered area, out of sunlight and heat will prolong hose life. Do not store hose where it could be stepped on or where other objects could crush or damage hose.

# MAINTENANCE



Use only a qualified mechanic for any adjustments, disassembly or any kind of repair .



**WARNING: TO AVOID PERSONAL INJURY, ALWAYS TURN MACHINE OFF, MAKE SURE ALL MOVING PARTS COME TO A COMPLETE STOP.**



**DISCONNECT SPARK PLUG WIRE BEFORE SERVICING UNIT.**



ENGINE: See engine manufacturer operator's instructions.



**RECONNECT SPARK PLUG WIRE, GUARDS AND HOSE BEFORE STARTING ENGINE.**

Remove and Service foam air cleaner and inner air filter every 25 hours of use or every 10 hours or less for extremely dusty conditions (see engine manual).

Keep engine and engine cooling fins clean from dust and debris build-up.

Replace any worn or damaged parts as required.

**DO NOT** operate if excessive vibration occurs. If excessive vibration occurs, shut engine off immediately. Remove spark plug wire and check for damaged impeller, loose impeller bolt, loose impeller key or lodged foreign objects. Refer to parts list (item 16) on page 11 for proper torque specifications.

## ENGINE

When servicing engine refer to specific manufacturers engine owner's manual. All engine warranty is covered by the specific engine manufacturer. If your engine requires warranty or other repair work contact your local servicing engine dealer. When contacting a dealer for service it is a good idea to have your engine model number available for reference(See table page 11). If you can not locate a servicing dealer in your area you can contact the manufacturers national service organization.

To reach:

**Briggs & Stratton:** 800-233-3723

**American Honda:** 800-426-7701

## IMPELLER REMOVAL

1. Wait for engine to cool and disconnect spark plug.
2. Disconnect hose from unit.
3. Remove boom assembly.
4. Remove cable assy. interlock (item 43), from front plate of assembly (item 41).
5. Remove front plate assembly (item 41).
6. Remove impeller bolt and lock washer.
7. Pull the impeller outward. If impeller slides freely, proceed to (steps 10 to 14 for TR units or to step 14 for HTR units). If not, complete steps 8 thru 9 as required.
8. Place two crowbars between impeller and housing on opposite sides. Pry impeller away from engine until it loosens. *Using a penetrating oil can help loosen a stuck impeller.*
9. If the impeller does not loosen, obtain a 1" (25.4mm) longer bolt of the same diameter and thread type as the impeller bolt. Thread longer bolt by hand into the crankshaft until bolt bottoms. Using a suitable gear or wheel puller against the bolt head and the impeller back-plate (near the blades), remove impeller from shaft.
10. **[TR ONLY]** Remove engine base mounting bolts, and nuts.
11. **[TR ONLY]** Access engine bolts on inside of housing that connect engine face to the fan housing. Bend ends of lock clip away from bolt heads and remove bolts.
12. **[TR ONLY]** Slide engine shaft out of impeller.
13. **[TR ONLY]** When impeller is free of the engine shaft, align impeller with opening, and diagonally lift impeller out of housing.
14. Using a new impeller bolt and lockwasher (and engine bolt lock clip, TR only), reinstall (engine for TR only) and new impeller in reverse order.
15. Tighten impeller bolt. Torque HTR1601V and TR1303H impeller bolt to [ 50 Ft. Lbs. (68 N·m)] and TR1103 to [ 60 Ft. Lbs. (81.4 N·m)] (see item 16 on page 11).
16. Reinstall spark plug wire.





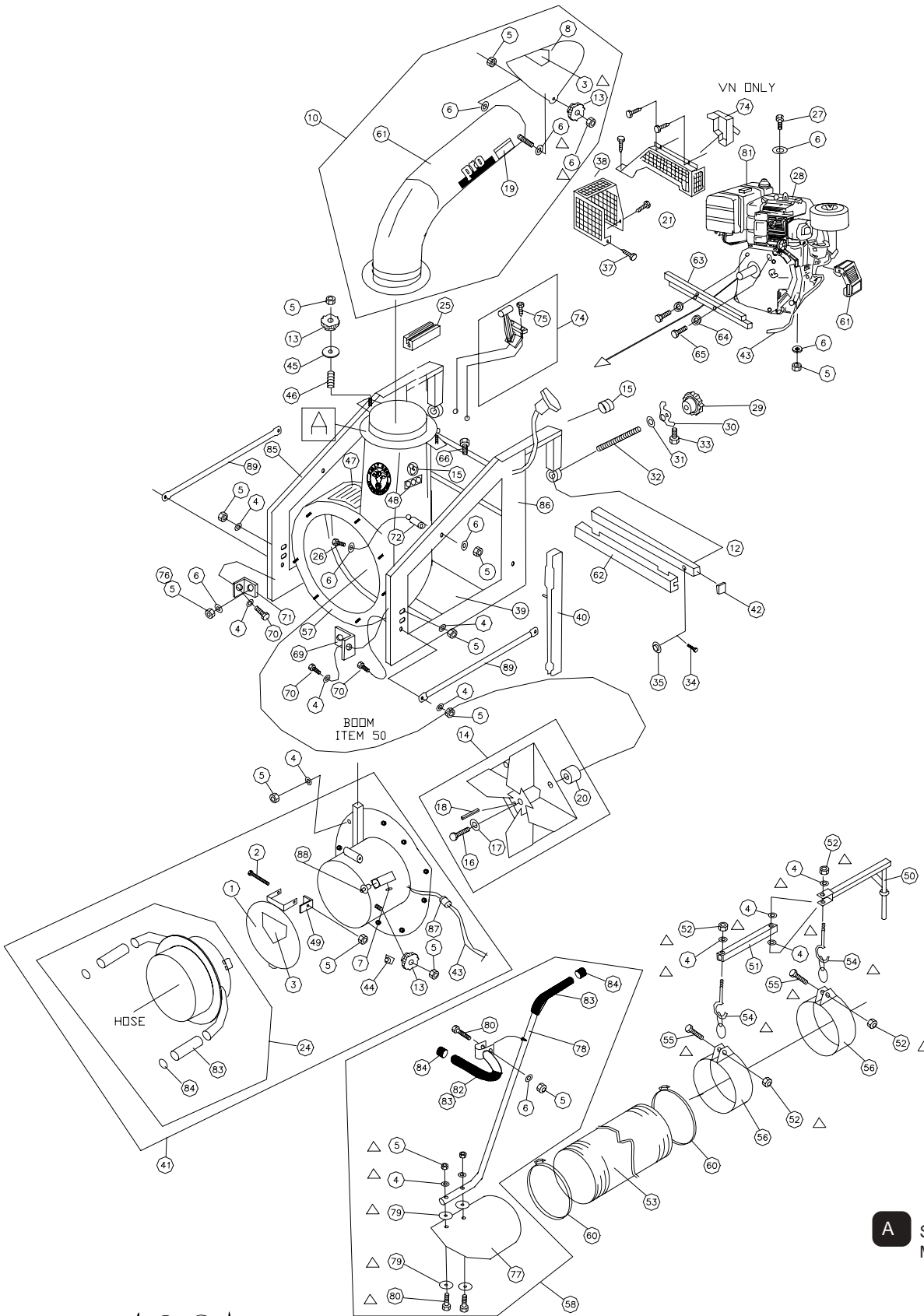

**A** SEE PAGE 9  
MAINTENANCE

**18 PARTS DRAWING**

**HTR1601V, TR1303H,  
TR1103**



\* Denotes standard hardware item that may be purchased locally.

△ Denotes parts found in parts bag assembly.

ITEM	DESCRIPTION	HTR1601V PART NO.	QTY	TR1303H PART NO.	QTY	TR1103 PART NO.	QTY
1	FLAPPER 10" INTAKE W/LABEL	810956	1	- - -	- -	- - -	- -
	FLAPPER 8" INTAKE W/ LABEL	- - -	- -	810558	1	810558	1
2	SCREW CAP 5/16-18 x 3 1/4	*8041037	1	*8041037	1	*8041037	1
3	LABEL DANGER KEEP HANDS AND FEET AWAY	400424	2	400424	2	400424	2
4	WASHER 5/16 SAE (11/32 ID x 11/16 OD x 1/16)	*8172008	25	*8172008	22	*8172008	22
5	NUT LOCK 5/16-18	*8160002	32	*8160002	28	*8160002	28
6	WASHER 5/16 FLAT CUT (3/8 I.D. x 7/8 O.D. x 1/16)	*8171003	16	*8171003	16	*8171003	12
7	PLUG 3/4"	811123	1	811123	1	811123	1
8	DEFLECTOR EXHAUST 7"	811111	1	811111	1	811111	1
9	CARRIAGE BOLT 5/16-18 x 3 1/2	*8024050	1	*8024050	1	*8024050	1
10	ELBOW ASSY TR/HTR	811109	1	811109	1	811109	1
11	SCREW CAP 5/16-18 x 1 3/4	*8041031	1	*8041031	1	*8041031	1
12	TUBE CLAMP	810953	1	810953	1	810953	1
13	KNOB	400339	4	400339	4	400339	4
14	IMPELLER ASSY (INCLUDES 16(1),17(1),18(1), 20(1))	810930	1	810974	1	810629	1
15	LABEL READ OWNER'S MANUAL	890301	1	890301	1	890301	1
16	SCREW CAP 3/8-24 x 2" GR 8 [50 Ft. Lbs. (68 N.m)]	810962	1	- - -	- -	- - -	- -
	SCREW CAP 3/8 - 24 X 2 1/4 GR 8 [50 Ft. Lbs. (68 N.m)]	- - -	- -	810932	1	- - -	- -
	SCREW CAP 7/16 - 20 X 1 1/4 GR 5 [60 Ft. Lbs. (81.4 N.m)]	- - -	- -	- - -	- -	800554	1
17	WASHER LOCK 3/8 TWISTED TOOTH	400502	1	400502	1	- - -	- -
	WASHER LOCK 7/16 TWISTED TOOTH	- - -	- -	- - -	- -	850132	1
18	KEY SQ. 1/4 x 2 3/4	*9201125	1	*9201125	1	- - -	- -
	KEY SQ. 1/4 X 2 1/4	- - -	- -	- - -	- -	*9201123	1
19	LABEL DANGER FLYING MATERIAL	810736	2	810736	2	810736	2
20	SPACER IMPELLER	830112	1	830112	1	- - -	- -
21	GUARD MANIFOLD	811059	1	- - -	- -	- - -	- -
22	GUIDE STARTER ROPE	830533	2	830533	2	830533	2
23	FRAME PANEL REAR	811106	1	811106	1	811106	1
24	COUPLER HOSE W/GRIP	811115	1	811116	1	811116	1
25	PAD FRAME SHORT	811120	2	811120	2	811120	2
26	CARRIAGE BOLT 5/16-18 x 3 1/4	*8024045	1	- - -	- -	- - -	- -
	CARRIAGE BOLT 5/16-18 x 3 1/2	- - -	- -	*8024054	1	*8024054	1
27	SCREW CAP 5/16-18 x 1 3/4	*8041031	4	*8041031	4	- - -	- -
	SCREW CAP 5/16-18 x 2 1/2	- - -	- -	- - -	- -	*8041034	4
28	ENGINE 16 H.P. V N W/CONTROL PANEL	810099	1	- - -	- -	- - -	- -
	ENGINE HONDA 11HP	- - -	- -	430366	1	- - -	- -
	ENGINE BRIGGS 11 HP INDUSTRIAL PLUS	- - -	- -	- - -	- -	430250	1
29	KNOB	850154	2	850154	2	850154	2
30	NUT LOCK W.A.	800227	2	800227	2	800227	2
31	WASHER 3/4, PLASTIC	800109	2	800109	2	800109	2
32	STUD 3/4 -10 x 5 1/2	810954	2	810954	2	810954	2
33	SCREW MACHINE #10-24 x 2	*8059143	2	*8059143	2	*8059143	2
34	PIN COTTER 1/8 x 1"	*8197031	2	*8197031	2	*8197031	2
35	WASHER 3/8 SAE	*8172009	10	*8172009	10	*8172009	10
36	NUT LOCK 3/8-16	*8160003	8	*8160003	8	*8160003	8
37	SCREW SHEET METAL 1/4 AB x 3/4	*8122082	3	- - -	-	- - -	- -
38	GUARD MUFFLER	811058	1	- - -	-	- - -	- -
39	BASE ENGINE	810907	1	810907	1	810907	1
40	PAD FRAME LONG	811122	2	811122	2	811122	2
41	PLATE FRONT 10" HTR W/INTERLOCK (INCL. 1,2,3,5(2),7,13,43,44,49,59,83,84)	811112	1	- - -	-	- - -	-
	PLATE FRONT 8" TR W/INTERLOCK (INCL. 1,2,3,5(2),7,13,43,44,49,59,83,84,87)	- - -	-	811113	1	811113	1
42	PLUG CAP 1" SQUARE	810535	2	810535	2	810535	2
43	CABLE ASSY SWITCH SV	890443	1	890443	1	890443	1
44	CLIP-CABLE LIFT	850200	3	850200	3	850200	3
45	WASHER-EXTENSION	810652	2	810652	2	810652	2
46	SPRING	400332	2	400332	2	400332	2
47	LABEL CAUTION	830138	1	830138	1	830138	1
48	LABEL EAR,EYE,BREATHING	890254	1	890254	1	890254	1
49	BRACKET STOP FLAPPER	810941	1	810941	1	810941	1
50	BOOM-PIVOT W.A.	810870	1	810870	1	810870	1
51	TUBE-SQUARE BOOM ARM	810875	1	810875	1	810875	1
52	NUT LOCK 1/4-20	*8160001	5	*8160001	5	*8160001	5
53	HOSE 10" x 12.5' HTR (COMES IN SEPERATE BOX)	810705	1	- - -	-	- - -	-
	HOSE 8" x 12.5' TR (COMES IN SEPERATE BOX)	- - -	-	810523	1	810523	1
54	CHAIN-LOOP ASSY	810878	2	810878	2	810878	2
55	SCREW CAP 1/4-20 x 1 3/4	*8041009	2	*8041009	2	*8041009	2
56	BAND HOSE BOOM 10" HTR	810868	2	- - -	-	- - -	-
	BAND HOSE BOOM 8" TR	- - -	-	810880	2	810880	2
57	HOUSING ASSY W/LABELS (INCLUDES 5(2), 13(2), 45(2), 46(2), 47, 48)	810912	1	810976	1	810976	1
58	NOZZLE ASSY 10" HTR (INCL. 4(2), 5(3), 6, 23, 77, 79(4), 80(2), 82, 83, 84)	811010	1	- - -	-	- - -	-
	NOZZLE ASSY 8" TR (INCL. 4(2), 5(3), 6, 23, 77, 79(4), 80(2), 82, 83, 84)	- - -	-	811009	1	811009	1
60	CLAMP HOSE 10" HTR	810706	2	- - -	-	- - -	-
	CLAMP HOSE 8" TR	- - -	-	810566	2	810566	2
61	ELBOW EXHAUST WA	811110	1	811110	1	811110	1
62	PAD FRAME CLAMP TUBE	811121	1	811121	1	811121	1
63	SUPPORT PLATE ENGINE / SPACER ENG.	810927	1	810965	1	- - -	-

19 Parts List continued from page 11.

\* Denotes standard hardware item that may be purchased locally.

ITEM	DESCRIPTION	HTR1601V PART NO.	QTY	TR1303H PART NO.	QTY	TR1103 PART NO.	QTY
64	WASHER LOCK 3/8	*8177012	2	*8177012	2	- - -	-
	WASHER LOCK 5/16 EXT. TOOTH	- - -	-	- - -	-	*8181008	2
65	SCREW CAP 3/8 - 16 X 3/4	*8041048	2	- - -	-	- - -	-
	SCREW CAP 3/8 - 16 X 1 1/2 ZP	- - -	-	8041052	2	- - -	-
	SCREW CAP 5/16 - 24 X 3/4 G5	- - -	-	- - -	-	*8042026	2
66	SCREW CAP 3/8 - 16 x 1"	*8041050	6	*8041050	6	*8041050	6
67	SCREW MACHINE #6-32 x 3/4	*8059094	2	*8059094	2	*8059094	2
68	NUT LOCK #6 - 32	*8164003	2	*8164003	2	*8064003	2
69	ANGLE BRKT R.H.	810917	1	811096	1	811096	1
70	SCREW CAP 5/16-18 x 1"	*8041028	10	*8041028	9	*8041028	9
71	ANGLE BRKT L.H.	810916	1	810969	1	810969	1
72	SPA CER	811097	1	811098	1	811098	1
73	WASHER FLAT CUT 1/4	*8171002	1	*8171002	1	*8171002	1
74	CONTROL THROTTLE ASSY	810904	1	810972	1	- - -	-
75	SCREW MACHINE 10-24 x 1/2"	- - -	-	*8123086	2	- - -	-
76	NUT LOCK 5/16-18 THIN HT.	- - -	-	8161041	1	8161041	1
77	NOZZLE FORMED STEEL 10"	811005	1	- - -	-	- - -	-
	NOZZLE FORMED STEEL 8"	- - -	-	811007	1	811007	1
78	HANDLE NOZZLE W / GRIP	811020	1	811020	1	811020	1
79	WASHER FENDER 5/16	*8172020	4	*8172020	4	*8172020	4
80	SCREW CAP 5 /16 - 18 X 1 1/2	*8041030	3	*8041030	3	*8041030	3
81	LABEL DO NOT FILL WHEN ENGINE IS HOT	400268	1	400268	1	400268	1
82	HANDLE LOOP NOZZLE	811019	1	811019	1	811019	1
83	GRIP HANDLE	500267	1	500267	1	500267	1
84	PLUG CAP	890132	2	890132	2	890132	2
85	FRAME SIDE RIGHT WA TR/HTR	811100	1	811100	1	811100	1
86	FRAME SIDE LEFT WA TR/HTR	811101	1	811101	1	811101	1
87	STRAIN RELIEF	500282	1	500282	1	500282	1
88	PLUNGER SWITCH	890440	1	890440	1	890440	1
89	TUBE HANDLE LIFT	811139	2	811139	2	811139	2

**20 TROUBLESHOOTING** *Before Requesting Service Review These Suggestions*

Problem	Possible Cause	Solution
Will not vacuum or has poor vacuum performance.	Nozzle height too high or too low. Clogged hose or exhaust. Excessive quantity of debris.	Adjust nozzle position. Unclog hose or exhaust (see page 6). Allow air to feed with debris.
Abnormal vibration.	Loose or out of balance impeller or loose engine.	Check impeller and replace if required. Check Engine.
Engine will not start.	Throttle & / or stop switch in off position. Out of gasoline. Bad or old gasoline. Spark Plug wire disconnected. Dirty air cleaner. Hose not installed, allowing interlock wire to ground.	Check stop switches, throttle, and gasoline. Connect spark plug wire. Clean or replace air cleaner. Or contact a qualified service person. Install hose onto housing.
Engine is locked, will not pull over.	Debris locked inside impeller. Engine problem.	See page 6, Clearing a clogged impeller housing. Contact an engine servicing dealer for engine problems.

**22.1 Engine Service and Warranty**  
Contact your nearest engine manufacturer's authorized servicing dealer.

**21 Serial Plate** Record your machine model, serial number and date-of-purchase and where purchased



**BILLY GOAT INDUSTRIES, INC.**

1803 S. Jefferson  
P.O. Box 308  
Lee's Summit,  
MO 64063 / USA  
Tel (816) 524-9666  
Fax (816) 524-6983



120 dB

Model	Serial No.
Unit(Weight)	Engine Power
<input style="width: 40px;" type="text"/> lbs. <input style="width: 40px;" type="text"/> kg	<input style="width: 40px;" type="text"/> kW <input style="width: 40px;" type="text"/> rpm

Purchase Date \_\_\_\_\_ Purchased from \_\_\_\_\_

**22 WARRANTY PROCEDURE**

Please fill in the WARRANTY CARD and send the upper part to Billy Goat. The WARRANTY terms are stated on the lower part which remains with the user. Whenever a Billy Goat Machine is faulty due to a defect in material and / or workmanship, the owner should make a warranty claim as follows:

- The Machine should be taken to the dealer from whom it was purchased or to an authorized Billy Goat dealer.
  - The owner should present the remaining half of the Warranty Registration Card, or, if this is not available, the invoice or receipt.
  - The Warranty Claim will be filled in by the authorized Billy Goat Dealer, who will send it with the faulty part to Billy Goat headquarters.
  - The Quality / Service department at Billy Goat headquarters will study the claim and parts and will notify their conclusions.
  - The decision by the Quality / Service department at Billy Goat headquarters to approve or reject a Warranty claim is final and binding.
- Note:* To process a Warranty Claim, it is necessary to quote the Model & Serial number which are printed on the Billy Goat Serial Plate.

**BILLY GOAT.** **BILLY GOAT INDUSTRIES INC.**  
1803 S.W. JEFFERSON STREET / LEE'S SUMMIT, MO 64082-2312 / USA  
PHONE: 816-524-9666 FAX: 816-524-6983 [www.billygoat.com](http://www.billygoat.com)