

1

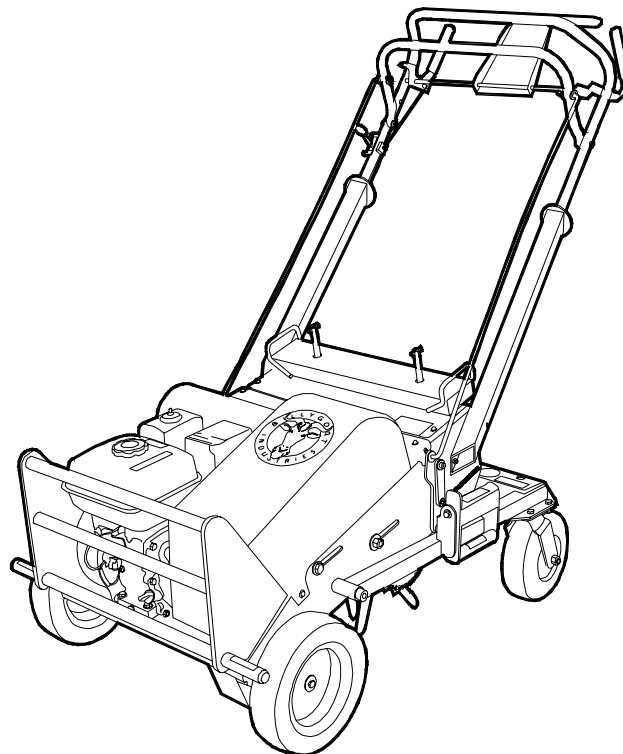

Patent Pending

***Thank You for Selecting
The Powerful
EZ AIR™ AERATOR***

Operator Owner's Manual

AE550, AE550H

3

Specifications

	AE550	AE550H
ENGINE: H.P.	5.5 (4.1 kW)	5.5 (4.1 kW)
ENGINE: TYPE	B&S OHV	HONDA OHV
ENGINE: FUEL CAP.	3.0 qt. (2.84 L)	3.88 qt. (3.41 L)
ENGINE: OIL CAP.	0.66 qt. (0.62 L)	0.69 qt. (0.65 L)
UNIT WEIGHT	290# (131.8 kg)	294# (133.6 kg)
REMOVABLE WEIGHT	36# (16.4 kg)	36# (16.4 kg)
NET UNIT WEIGHT	326# (148.2 kg)	330# (150.0 kg)
WEIGHT: SHIPPING	447# (203.2 kg)	451# (205.0 kg)

5

IN THE INTEREST OF SAFETY



BEFORE STARTING ENGINE, READ AND UNDERSTAND THE "ENTIRE OPERATOR'S MANUAL & ENGINE MANUAL."



THIS SYMBOL MEANS WARNING OR CAUTION. DEATH, PERSONAL INJURY AND/OR PROPERTY DAMAGE MAY OCCUR UNLESS INSTRUCTIONS ARE FOLLOWED CAREFULLY.



WARNING: The Engine Exhaust from this product contains chemicals known to the State of California to cause cancer, birth defects or other reproductive harm.

WARNING: DO NOT

1. **DO NOT** run engine in an enclosed area. Exhaust gases contain carbon monoxide, an odorless and deadly poison.

2. **DO NOT** place hands or feet near moving or rotating parts.

3. **DO NOT** store, spill or use gasoline near an open flame, or devices such as a stove, furnace, or water heater which use a pilot light or devices which can create a spark.

4. **DO NOT** refuel indoors where area is not well ventilated. Outdoor refueling is recommended.

5. **DO NOT** fill fuel tank while engine is running. Allow engine to cool for 2 minutes before refueling. Store fuel in approved safety containers.

6. **DO NOT** remove fuel tank cap while engine is running.

7. **DO NOT** operate engine when smell of gasoline is present or other explosive conditions exist.

8. **DO NOT** operate engine if gasoline is spilled. Move machine away from the spill and avoid creating any ignition until the gasoline has evaporated.

9. **DO NOT** transport unit with fuel in tank.

10. **DO NOT** smoke when filling fuel tank.

11. **DO NOT** choke carburetor to stop engine. Whenever possible, gradually reduce engine speed before stopping.

12. **DO NOT** run engine at excessive speeds. This may result in injury &/or damage to unit.

13. **DO NOT** tamper with governor springs, governor links or other parts which may change the governed engine speed.

14. **DO NOT** tamper with the engine speed selected by the engine manufacturer.

15. **DO NOT** check for spark with spark plug or spark plug wire removed. Use an approved tester.

16. **DO NOT** crank engine with spark plug removed. If engine is flooded, place throttle in "FAST" position and crank until engine starts.

17. **DO NOT** strike flywheel with a hard object or metal tool as this may cause flywheel to shatter in operation. Use proper tools to service engine.

18. **DO NOT** operate engine without a muffler. Inspect periodically and replace, if necessary. If engine is equipped with muffler deflector, inspect periodically and replace, if necessary, with correct deflector.

19. **DO NOT** operate engine with an accumulation of grass, leaves, dirt or other combustible material in the muffler area.

20. **DO NOT** use this engine on any forest covered, brush covered, or grass covered unimproved land unless a spark arrester is installed on the muffler. The arrester must be maintained in effective working order by the operator. In the State of California the above is required by law (Section 4442 of the California Public Resources Code). Other states may have similar laws. Federal laws apply on federal lands.

21. **DO NOT** touch hot muffler, cylinder, or fins because contact may cause burns.

22. **DO NOT** run engine without air cleaner or air cleaner cover.

23. **DO NOT** operate during excessive vibration!

24. **DO NOT** leave machine unattended while in operation.

25. **DO NOT** park machine on a steep grade or slope.

WARNING: DO



1. **ALWAYS DO** remove the wire from the spark plug when servicing the engine or equipment TO PREVENT ACCIDENTAL STARTING.

2. **DO** keep cylinder fins and governor parts free of grass and other debris which can affect engine speed.

3. **DO** pull starter cord slowly until resistance is felt. Then pull cord rapidly to avoid kickback and prevent hand or arm injury.

4. **DO** examine muffler periodically to be sure it is functioning effectively. A worn or leaking muffler should be repaired or replaced as necessary.

5. **DO** use fresh gasoline. Stale fuel can gum carburetor and cause leakage.

6. **DO** check fuel lines and fittings frequently for cracks or leaks. Replace if necessary

7. **Follow** engine manufacturer operating and maintenance instructions.

8. **Inspect** machine and work area before starting unit.

6

TABLE OF CONTENTS

SAFETY INSTRUCTIONS	2
GENERAL SAFETY	3
ASSEMBLY	3
CONTROLS	4
LABELS	4
OPERATION	6 - 7
MAINTENANCE	10-11
PARTS DRAWING & LIST...	8 - 9
TROUBLESHOOTING	12
WARRANTY PROCEDURE	12

7

SOUND

SOUND TESTS

Sound tests conducted were in accordance with 2000/14/EEC and were performed on 02/05/2002 under the conditions listed:

GENERAL CONDITION: Cloudy



L_{WA}

101 dB

TEMPERATURE: 42°F (6°C)

3.5 MPH (5.6 kmh)

WIND DIRECTION: North East

HUMIDITY: 53%

BAROMETRIC PRESSURE: 30.29" Hg (769 mm Hg)

8

VIBRATION

VIBRATION LEVELS 3.6 g max.

Vibration levels at the operators handles were measured in the vertical, lateral, and longitudinal directions using calibrated vibration test equipment.

Tests were performed on 02/06/2002 under the conditions listed:

GENERAL CONDITION: Cloudy

TEMPERATURE: 37°F (3 °C)

WIND SPEED: 5 MPH (8 kmh)

WIND DIRECTION: North East

HUMIDITY: 90%

BAROMETRIC PRESSURE: 30.13" Hg (765 mm Hg)

GENERAL SAFETY

For your safety and the safety of others, these directions should be followed:



Do not operate this machine without first reading owner's manual and engine manufacturer's manual.



Use of Ear Protection is recommended while operating this machine.



Use of Eye and Breathing protection is recommended when using this machine, especially in dry and dusty conditions.



Wearing gloves is recommended while operating this machine.

•**DO NOT** place hands or feet underneath unit, near debris outlet or near any moving parts.

•**DO NOT** start engine without tine height adjust lever in up position and clutch bail disengaged.

•**DO NOT** start or operate machine with guards removed.

•**DO NOT** perform any service on the unit without removing the spark plug wire.

•**DO NOT** operate a machine that exhibits excessive vibration.

•**DO NOT** operate this machine on slopes greater than 19°.

•**DO NOT** use this unit on any surface other than grass lawns.

•**DO NOT** allow children to operate this equipment.

•**DO** read all maintenance and operating instructions before beginning work.

•**DO** read all engine manufacturers operating and maintenance instructions.

•**DO** inspect lawn before beginning work. Remove all rocks, wire, string, or other objects that can present a hazard during work prior to starting.

•**DO** identify and mark all fixed objects to be avoided during work, such as sprinkler heads, water valves, buried cables, or clothes line anchors, etc.

ASSEMBLY



Read all safety and operating instructions before assembling or starting this unit.



PUT OIL IN ENGINE BEFORE STARTING

Your Billy Goat EZ-Air aerator is shipped from the factory in one carton, completely assembled.

1. **REMOVE** lock nuts from the upper handle mounting stud. These will be reused.

2. **UNFOLD** the upper handle and pivot it back into the operating position. NOTE: There are two height positions that the handle can be set in. The lower stud places the handle in the highest position the upper stud places the handle in the lowest operating position.

3. **SECURE** the upper handle by positioning the lowermost mounting hole over the chosen handle mounting stud and tightening the hand knob on the handle pivot bolt to secure the handle in position. NOTE: If the folding handle feature is not desired or the handle is to be kept in the extended position for an long period of time, we recommend using the hardware that is provided in you parts bag to permanently attach the handle. See FOLDING HANDLE on page 7.

4. **REPLACE** the lock nuts that were removed in step one and fully tighten them to complete securing the handle in place.

5. **ATTACH** the lift rods, one on each side of the unit. Remove the hair pins that are shipped in free end of the rods. Pivot the rods up and along the side of the unit and slip the free end of the rod into the lift link bars one on each side of the unit. With the rods in position, replace the hair pins in the holes that they were removed from to lock the lift rods in place.

5. **CHECK** engine oil level and fill to proper level. See engine owners manual for type and amount of oil to use. Move the tine height adjust lever to the down position, to level engine during checking.

6. **CONNECT** spark plug wire. HONDA ONLY: Set the engine stop switch to the on position. You will use the stop switch on the handle during operation.

PACKING CHECKLIST

These items should be included in your carton. If any of these parts are missing, contact your dealer.



Engine Manual Per Model

Literature Assembly 360177

Per Model	
Check <input type="checkbox"/>	Briggs & Stratton 5.5 Intek OHV
Check <input type="checkbox"/>	Honda 5.5 OHV
Check <input type="checkbox"/>	Owner's Manual 360178
Check <input type="checkbox"/>	Warranty Card 400972
Check <input type="checkbox"/>	EU Declaration of Conformity & EU Distributor List 360194

13 CONTROLS

ENGINE SPEED CONTROL

HONDA ENGINE CONTROLS

Increase Speed

START

Decrease Speed

STOP

Throttle lever on handle

FUEL VALVE

CHOKE LEVER

Engine speed is set by using the throttle control lever, located in the middle of the operators handle.

B & S ENGINE CONTROLS

Decrease Speed

STOP

Increase Speed

START

Throttle lever on handle

Set lever to choke position when starting a cold engine

||| RUN

CHOKE |||

14 INSTRUCTION LABELS

These labels should be included on your Aerator. If any of these labels are damaged, replace them before putting this equipment into operation. Item and part numbers are given to help in ordering replacement labels.

WARNING
EXPLOSIVE FUEL
STOP ENGINE AND ALLOW TO COOL BEFORE REFUELING.

Label Hot Engine
Part No.400268

DANGER
KEEP HANDS AND FEET AWAY

Label Danger
Keep Hands
and Feet Away
Part No.400424

LIFT HERE

Label LIFT HERE
Part No.360187

WARNING
THE UNIT WEIGHS OVER 300 LBS.
LIFT HERE WITH CAUTION

Label Warning Unit Weight
Part No.360188

WARNING

Label Danger Guard
Part No.900327

START

STOP

Label Throttle Control
Part No.810656

OPERATING INSTRUCTIONS

- TO START MOVE ENGINE STOP SWITCH TO "ON" AND PULL ROPE.
- NOTE: IT MAY BE NECESSARY TO USE THE ENGINE CHOKE IF ENGINE IS COLD.
- PUSH FORWARD ON OPERATOR'S BAIL TO ENGAGE TINES IN GROUND.
- PUSH FORWARD ON OPERATOR'S BAIL TO ENGAGE DRIVE AND START AERATING.
- DURING OPERATION PUSHING DOWN ON OPERATOR'S HANDLE WILL MAXIMIZE CORING DEPTH.
- RELEASE BAIL TO STOP UNIT.
- NOTE: ENGINE WILL CONTINUE TO RUN WITH BAIL DISENGAGED.
- TO TURN UNIT PULL BACK ON THE LEFT HANDLE TO LIFT TINES OUT OF GROUND. ORIGINAL TURNING CAN BE MADE WITHOUT LIFTING THE TINES.
- WITH TINES UP, PUSH FORWARD ON OPERATOR'S BAIL TO ENGAGE WHEELDRIVE FOR ASSISTED TURNING.
- TO STOP ENGINE, MOVE ENGINE STOP SWITCH TO "OFF".

CAUTION

READ OWNERS MANUAL BEFORE OPERATING

USE PERSONAL PROTECTION EQUIPMENT

BEFORE STARTING, MAKE SURE:

- TINE DEPTH CONTROL BAIL IS IN UP POSITION.
- ALL GUARDS ARE ATTACHED.

FOR PREVENTATIVE MAINTENANCE

- CHECK ENGINE OIL DAILY.
- INSPECT AND CLEAN ENGINE AIR FILTER DAILY. REPLACE AS NEEDED.
- GREASE ALL BEARINGS AND CHECK GEAR REDUCTION OIL LEVEL ON EVERY ENGINE OIL CHANGE.

ALWAYS:

- INSPECT MACHINE BEFORE EACH USE AND REPLACE ANY WORN AND DAMAGED PARTS.
- PROPERLY SECURE EQUIPMENT BEFORE TRANSPORTING.
- DISCONNECT SPARK PLUG WIRE BEFORE SERVICING UNIT.
- USE ONLY A QUALIFIED MECHANIC TO SERVICE THIS MACHINE.

Label Instructions AE - Part No. 360191

15 ENGINE LABELS

Briggs & Stratton

THIS ENGINE EQUIPPED WITH LOW OIL SENSOR, IF ENGINE WILL NOT START, CHECK OIL LEVEL

WARNING

- Read and follow Operating Instructions before running engine.
- Gasoline is flammable. Allow engine to cool at least 2 minutes before fueling.
- Engines emit carbon monoxide, DO NOT run in enclosed area.

Honda

IMPORTANT ENGINE INFORMATION - HONDA MOTOR CO., LTD
ENGINE FAMILY: THN163U1G1RA DISPLACEMENT - 163cm³
TUNE UP SPECIFICATION "REFER TO OWNER'S MANUAL FOR MAINTENANCE SPECIFICATIONS AND ADJUSTMENTS". THIS ENGINE MEETS 1995 CALIFORNIA EMISSION REGULATIONS FOR UTILITY AND LAWN AND GARDEN EQUIPMENT ENGINES.

- READ OWNER'S MANUALS BEFORE OPERATION.
- LIRE LE MANUEL D'UTILISEATEUR AVANT USAGE.
- VOR INBETRIEBNAHME UNBEDINGT BEDIENUNGSANLEITUNG DURCHLESEN.
- NO UTILIZAR SIN ANTES NO HABER LEIDO EL MANUAL.

OIL ALERT

WHEN OIL LEVEL LOW, ENGINE STOPS IMMEDIATELY.

Operation

INTENDED USE: This machine is designed for aerating established lawns and large grass covered areas. The machine should not be used for any other purpose than that stated above.

DO NOT operate if excessive vibration occurs. If excessive vibration occurs, shut engine off immediately and check for damaged or worn tine reel, loose pulley bolts or set screws, loose engine or lodged foreign objects. (See trouble shooting section on page 12).

Like all mechanical tools, reasonable care must be used when operating machine.



Inspect machine work area and machine before operating. Make sure that all operators of this equipment are trained in general machine use and safety.

STARTING ENGINE



ENGINE: See engine manufacturer's instructions for type and amount of oil and gasoline used.

Engine must be level when checking and filling oil and gasoline.

GEAR REDUCTION: See engine manufacturer's instructions for type and amount of oil used. Engine must be level when checking and filling the gear reduction case. The engine is shipped from the factory with oil in the gear case. It should be checked before first use.

ENGINE SPEED: Controlled by throttle lever on the upper handle. Under normal conditions, operate at the minimum throttle speed to accomplish your task.

NOTE: The unit ground speed varies with the engine speed.

FUEL VALVE: Move fuel valve to "ON" position
Honda: Located below the air cleaner on the engine.
Briggs: Located on face of the engine.

ENGINE STOP SWITCH: Move to "ON" position
Honda only: Located on side of engine. During normal operation use the remote stop switch on the operators handle.

CHOKE: Engage the choke when starting a cold engine.
Honda: Located below the air cleaner on the engine.
Briggs: Located on top of the air cleaner on the engine.

THROTTLE: Move the throttle control on the upper handle to fast position. Pull starting rope to start engine.



IF YOUR UNIT FAILS TO START:
See Troubleshooting on page 12.

NOTE: Honda engines are equipped with a low oil sensor to prevent engine damage. When it senses a low oil condition (i.e. unit is operating or sitting on a steep slope) the engine shuts down. The low oil condition must be corrected before the engine can be restarted. See the engine owners manual for more information.

TINES RAISING/LOWERING

The tines are raised or lowered into the ground by operating the tine engagement lever on the upper handle. Tine penetration is very dependent on surface preparation. READ the operation section before aerating.

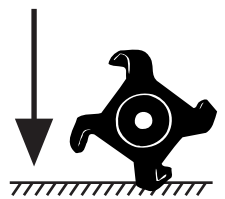
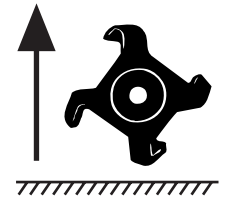

AERATING OPERATION



DO NOT- Use this machine on any surface other than a lawn or similar area.

DO NOT- Use this machine on slopes in excess of 19°.

DO NOT- Allow persons unfamiliar with this equipment to operate it.

DO NOT- Allow children to operate this equipment.

MOW: Mow the lawn to it's normal cut height.

WATER: For the best performance and maximum tine penetration the lawn should be thoroughly watered the day before aeration.

INSPECT lawn before beginning work. Remove all rocks, wire, string, or other objects that can present a hazard during work prior to starting.

IDENTIFY and mark all fixed objects to be avoided during work, such as sprinkler heads, water valves, buried cables, or clothes line anchors, etc.

START ENGINE: See above.

SET SPEED: The ground speed of your aerator varies with the engine speed. Set the engine at approximately half throttle to start. Speed may be increased based on the turf conditions (i.e. large flat areas) and operator experience. Speed should be lowered when operating under adverse turf conditions (i.e. fenced areas, hills, or slopes).

MOVE: Be sure the tine engagement control is in the up position (tines out of the ground) and engage the wheel drive by squeezing the operators clutch bail against the handle. Transport the aerator to the work area.

AERATOR OPERATION CONT'



ENGAGE TINES: With the aerator in the work area, release the clutch bail and push forward on the tine engagement lever, lowering the tines into the dirt.

AERATE: Engage the operators clutch bail by pushing it forward to the handle, and start aerating.

NOTE: For maximum tine penetration apply downward pressure on the handle.

TURNING: At the end of an aerating run, release the clutch bail and pull back on the tine engagement control to lift the tines out of the ground. Using the handle swivel the rear of the unit to bring it around and line up for the next pass.

NOTE: Engage the clutch bail to use the front wheel drive to aid in turning the unit.

TRANSPORT: Be sure to lift the tine engagement lever (tine out of the ground) before transporting away from the work area.

HANDLING & TRANSPORTING



CAUTION: This unit is heavy. It requires at least two people to lift it.

REMOVE: The aerator is equipped with a removable rear weight. Remove the weight when loading and unloading the unit. The weight can be removed by rotating the locking tabs on the weight mounting pins and lifting it straight up. See Fig. 1 below.

NOTE: The removable weight is also heavy and should be handled carefully and secured in place during transport.

LIFTING: The aerator is equipped with lift handles. After removing the weight lift the unit with two people one on each side of the unit. Grip the unit at the points marked "LIFT HERE" when lifting. Lift using your legs and not your back. See Fig. 2

USING RAMPS: Use ramps that are of adequate strength for a unit of this weight. When loading the aerator using ramps be sure the ramp is not too steep and that the surface of the ramp provides good traction.



Fig. 1

Hints!

AERATING TIPS

WATER: For the best performance and maximum tine penetration the lawn should be thoroughly watered the day before aeration.

SLOPES: Do not operate the aerator on steep slopes. Use extreme caution when operating on any sloped surface. For lesser sloped areas operate the unit, traversing up and down at a 45 degree angle to the slope rather than straight across. Extended operation on steep slopes can cause engine damage.

NOTE: DO NOT release the operators clutch bail when operating on a slope. This will allow the unit to free wheel and allow the unit to roll down the slope.

NOTE: Honda engines are equipped with a low oil sensor to prevent engine damage. When it senses a low oil condition (i.e. unit is operating or sitting on a steep slope) the engine shuts down. The low oil condition must be corrected before the engine can be restarted. See the engine owners manual for more information.

TINE PENETRATION: Maximum tine penetration is achieved by applying downward pressure on the handle during operation.

TURNING: At the end of a pass the tines can be lifted out of the ground to turn by lifting straight up on the operators handle.

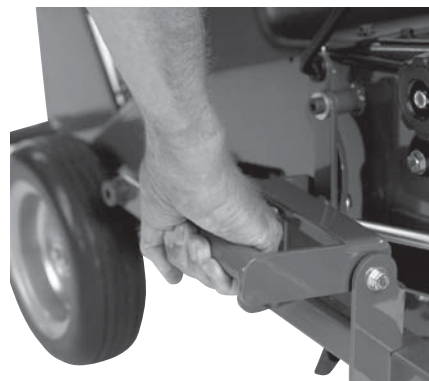

Fig. 2

ADJUSTING HANDLE HEIGHT

This unit is equipped with a height adjustable upper handle to allow for multiple operator heights.

TO ADJUST THE HANDLE HEIGHT:

1. Remove the lock nuts (item 50) that secure the handle, one on each side, to the lower handle mounting studs. See Fig. 1
2. Loosen the handle mounting bolts (item 51), one on each side, (See Fig. 3) and push the handle out and away from the lower handle mounting studs.
3. The handle is now free to rotate. Adjust the handle to the desired height. The BOTTOM handle mounting stud corresponds with the highest handle position. The TOP handle mounting stud corresponds with the lowest handle mounting position.
4. Completely tighten the handle mounting bolts (item 51), and replace the lock nuts (item 50) to secure the handle in place.

FOLDING HANDLE

This unit is equipped with a folding upper handle for easier storage. TO FOLD THE HANDLE:

1. Remove the lock nuts that secure the handle, one on each side, to the lower handle mounting studs. See Fig. 1
2. Remove the hair pins that secure the tine lift rods, one on each side, to the tine lift links. See Fig. 2
3. Slide the rods out of the lift links and replace the pins in the holes they were removed from for storage.
4. Rotate the lift rods down and back until they are hanging down and to the rear of the unit.
5. Loosen the handle mounting bolts, one on each side, (Fig. 3) and push the handle out and away from the lower handle mounting studs.
6. The handle is now free to rotate. Rotate it up and toward the front of the unit while holding the tine engagement control lever against the rear of the upper handle. The handle will rotate into a position with the top of the handle hooking over the front bumper of the unit.

NOTE: Replace the lock nuts (item 50) on the lower handle mounting studs for storage.



Fig. 1

UNIT STORAGE

⚠ Never store engine indoors or in enclosed poorly ventilated areas with fuel in tank, where fuel fumes may reach an open flame, spark or pilot light, as on a furnace, water heater, clothes dryer or other gas appliance.

If engine is to be unused for 30 days or more, prepare as follows:

⚠ Remove all gasoline from carburetor and fuel tank to prevent gum deposits from forming on these parts and causing possible malfunction of engine. Drain fuel outdoors, into an approved container, away from open flame. Be sure engine is cool. Do not smoke. Run engine until fuel tank is empty and engine runs out of gasoline.

NOTE: Fuel stabilizer (such as Sta-Bil) is an acceptable alternative in minimizing the formation of fuel gum deposits during storage. Add stabilizer to gasoline in fuel tank or storage container. Always follow mix ratio found on stabilizer container. Run engine at least 10 min. after adding stabilizer to allow it to reach the carburetor.

PARKING

⚠ NEVER PARK THIS UNIT ON A SLOPE OF ANY KIND. Always keep tines in the up position when parking the unit.

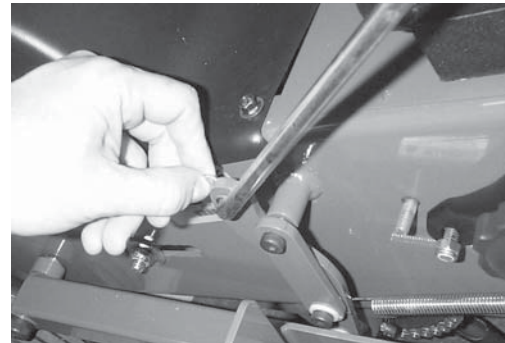
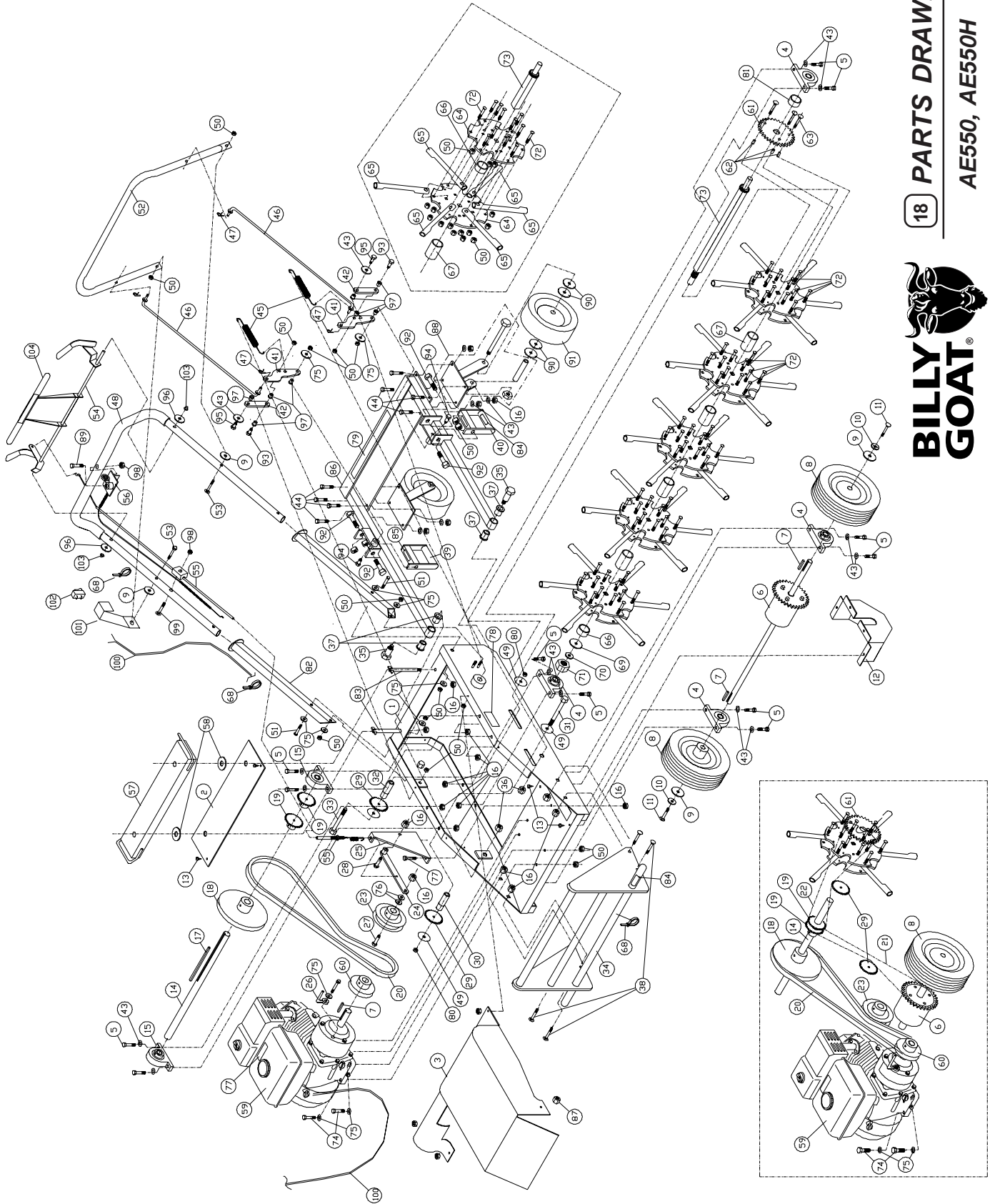

Fig. 2



Fig. 3



18 PARTS DRAWING
AE550, AE550H



ITEM NO.	DESCRIPTION	AE550H Part No.	QTY	AE550 Part No.	QTY
1	FRAME ASSEMBLY	360130	1	360130	1
2	GUARD TINE COVER	360160	1	360160	1
3	GUARD DRIVE COVER	360125	1	360201	1
4	BEARING 3/4" PILLLOW BLOCK	350133	4	350133	4
5	SCREWCAP 3/8-16 x 1 1/4	8041051	14	8041051	14
6	DIFFERENTIAL 35T AERATOR	360111	1	360111	1
7	KEY SQUARE 3/16 x 3/16 x 1.25	9201080	3	9201080	3
8	WHEEL 10.5" SEMI.PN. W3/4" KEYPED HUB	360157	2	360157	2
9	WASHER 5/16 FENDER	8172020	4	8172020	4
10	WASHER LOCK 5/16 TWISTED TOOTH	8181008	2	8181008	2
11	SCREWCAP 5/16-18 x 1"	8041028	4	8041028	4
12	GUARD DIFFERENTIAL AE	360196	1	360196	1
13	SCREW SELF TAP 1/4 x 3/4"	510208	8	510208	8
14	JACKSHAFT AERATOR	360110	1	360110	1
15	BEARING 1" PILLLOW BLOCK	810700	2	810700	2
16	NUT LOCK 3/8-16	8160003	40	8160003	40
17	KEY SQUARE 1/4 x 1/4 x 6"	9201143	1	9201143	1
18	PULLEY 8" x 1" BORE	360118	1	360118	1
19	SPOCKET 16TX 1" BORE	360113	2	360113	2
20	BELT 4L x 43" POWER RATED	360120	1	360120	1
21	CHAIN #40 x 94 PITCH O-RING (WHEEL)	360115	1	360115	1
22	CHAIN #40 x 76 PITCH O-RING (TINE)	360114	1	360114	1
23	PULLEY IDLER 4.5"	500270	1	500270	1
24	ARM IDLER WA	510199	1	510199	1
25	BRACKET MOUNT IDLER	360121	1	360121	1
26	BELT FINGER FRONT AE	360219	1	360219	1
27	SCREWCAP 3/8-16 x 1 1/2	8041052	1	8041052	1
28	BOLT SHOULDER 1/2 x 1	500114	1	500114	1
29	SPROCKET IDLER 17T x 5/8" BORE	360116	2	360116	2
30	SPACER SPROCKET IDLER 2.5"	360123	1	360123	1
31	SCREW CAP 1/2 - 13 x 4	8041106	1	8041106	1
32	SPACER SPROCKET IDLER 1.3"	360124	1	360124	1
33	SCREW CAP 1/2 - 13 x 2.5"	8041100	1	8041100	1
34	BUMPER	360139	1	360139	1
35	BOLT SHOULDER 3/4 x 2.5	360146	2	360146	2
36	NUT LOCK 5/8-11 THIN	8161046	2	8161046	2
37	BUSHING PIVOT	360183	4	360183	4
38	BOLT CARRIAGE 3/8-16 x 1.25"	8024059	4	8024059	4
39	HANDLE LIFT RH WA	360148	1	360148	1
40	HANDLE LIFT LH WA	360149	1	360149	1
41	LINK LIFT LOWER	360151	2	360151	2
42	LINK LIFT UPPER	360150	2	360150	2
43	WASHER FLAT 3/8 SAE	8172009	24	8172009	24
44	SCREWCAP 3/8 - 16 x 1	8041050	8	8041050	8
45	SPRING EXTENSION	360154	2	360154	2
46	ROD LIFT	360166	2	360166	2
47	PIN HAIR 1/4	900471	4	900471	4
48	HANDLE UPEER AE	360210	1	360210	1
49	FLAT WASHER 1/2	8171006	4	8171006	4
50	NUT LOCK 5/16-18	8160002	87	8160002	87
51	KNOB HANDLE	400339	2	400339	2
52	HANDLE LIFT	360167	1	360167	1

ITEM NO.	DESCRIPTION	AE550H Part No.	QTY	AE550 Part No.	QTY
63	BOLT SHOULDER 3/8 X 1	360152	2	360152	2
64	BAIL CLUTCH	360217	1	360217	1
65	CABLE CLUTCH ASSY	360119	1	360119	1
66	CABLE THROTTLE ASSY	360202	1	360202	1
67	WEIGHT	360162	1	360162	1
68	WASHER RUBBER 5/8 x 1.5	430210	2	430210	2
69	ENGINE 5.5 HP	360126	1	360127	1
70	PULLEY ENGINE	360117	1	360117	1
71	SPROCKET 42 T	360106	1	360106	1
72	SPACER	360107	3	360107	3
73	CAP SCREW 5/16-18 x 1.75"	8041031	3	8041031	3
74	TINE PLATE	360101	10	360101	10
75	TINE	360100	30	360100	30
76	SPACER	360105	6	360105	6
77	SPACER	360104	4	360104	4
78	TY-WRAP	900407	3	900407	3
79	WASHER	350153	1	350153	1
80	WASHER LOCK 7/8" INTERNAL	350154	1	350154	1
81	NUT JAM 7/8 - 14	350155	1	350155	1
82	BOLT CARRIAGE 5/16 - 18 x 1.75"	8024043	60	8024043	60
83	SHAFT TINE DRIVE	360102	1	360102	1
84	SCREW CAP 5/16 - 18 x 1.5"	8041030	4	8041030	4
85	WASHER FLAT CUT 5/16	8171003	15	817003	15
86	WASHER 1/4 FLAT CUT	8171002	2	8171002	2
87	LABEL HOT ENGINE	400268	1	400268	1
88	LABEL DANGER GUARD	900327	2	900327	2
89	LABEL INSTRUCTIONS AE	360191	1	360191	1
90	NUT LOCK 1/2 - 13	8161044	2	8161044	2
91	SPACER	360109	1	360109	1
92	HANDLE LOWER WA	360209	2	360209	2
93	PIN MOUNT BAR	360161	2	360161	2
94	LABEL LIFT HERE	360187	4	360187	4
95	LABEL WARNING WEIGHT	360188	2	360188	2
96	FRAME REAR WA	360143	1	360143	1
97	NUT FLANGE 1/4-20	900453	4	900453	4
98	RIG CASTER w/AXLE; NUT & BUSHING	360155	2	360155	2
99	BOLT CARRIAGE 1/4-20 x 1 3/4	8024025	1	8024025	1
100	SPACER WASHER NYLON	800109	8	800109	8
101	TIRE & WHEEL 8"	360156	2	360156	2
102	BOLT SHOULDER 3/8 x 1/2"	830528	4	830528	4
103	BOLT SHOULDER 3/8 x 3/4"	360184	2	360184	2
104	BOLT SHOULDER 3/8 X 1"	360152	2	360152	2
105	BOLT SHOULDER 3/8 x 2"	360153	2	360153	2
106	WASHER 3/8 DIA F.C.	8171004	2	8171004	2
107	BUSHING SHOULDER NYLON 3/8 ID	360175	8	360175	8
108	NUT LOCK 1/4x20	8160001	2	8160001	2
109	SCREW CAP 1/4 - 20 x2"	8041010	1	8041010	1
110	HARNES WIRE AE	360199	1	360199	1
111	BRACKET MOUNT SWITCH	430141	1	430141	1
112	SWITCH ON-OFF	500311	1	500311	1
113	NUT - PAL 3/8	360218	2	360218	2
114	GRIP LEVER	500181	4	500181	4

MAINTENANCE



Use only a qualified mechanic for any adjustments, disassembly or any kind of repair .



WARNING: TO AVOID PERSONAL INJURY, ALWAYS TURN MACHINE OFF, MAKE SURE ALL MOVING PARTS COME TO A COMPLETE STOP.



DISCONNECT SPARK PLUG WIRE BEFORE SERVICING UNIT.



ENGINE: See engine manufacturer's service instructions.



REPLACE ALL GUARDS, BEFORE STARTING ENGINE.



USE ONLY BILLY GOAT ORIGINAL EQUIPMENT PARTS FOR REPLACEMENT AND REPAIR

TINE ROW KIT 360197

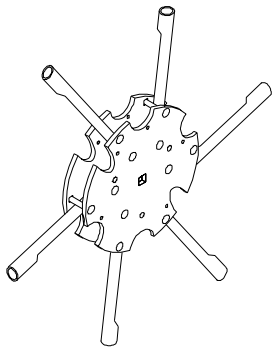

Complete tine row set for replacement of one complete row of tines. Includes mounting plates, spacer, and all hardware.

TINE KIT 360100



Individual coring tine for replacement of worn or broken tines.

Tip!!!

Spraying tines with a rust preventing lubricant can increase tine life and allow for easier replacement of worn or damaged tines.

TINE REEL REMOVAL AND TINE ROW REPLACEMENT

TINE REEL REMOVAL

NOTE: Tine reel removal is only necessary to replace an entire tine row or for other major unit maintenance. Individual tines can be replaced by following the TINE REPLACEMENT instructions.

1. Wait for engine to cool and disconnect spark plug.
2. Remove the top guard by removing the four screws, two on each side, that secure it to the frame.
3. Release the tension on the chain. See CHAIN TENSION ADJUSTMENT in this manual.
4. Remove the four bolts and nuts, two on each side, holding the tine reel bearings in place. BE CAREFUL the tine reel is heavy and sharp. Take precautions to not allow it to fall when the bearing bolts are removed.
5. Lift the reel up and to the side to remove it from the drive chain.
6. See TINE ROW REPLACEMENT for instructions on maintenance.
7. To reinstall the reel follow the above steps in reverse.
8. Replace the guard and reinstall the four screws that secure it in place.

TINE ROW REPLACEMENT

1. Wait for engine to cool and disconnect spark plug.
2. Remove the top guard by removing the four screws, two on each side, that secure it to the frame.
3. Remove the tine reel per the TINE REEL REMOVAL instructions.
4. Remove the nut at the end of the tine reel shaft that secures the tine rows in place.
5. Remove the tine rows and spacers as necessary to replace the defective part. Be sure to note the order in which the spacers were removed for later reassembly.
6. Reassemble the tine reel in the exact order that it was disassembled.
7. Tighten the nut that secures the tine rows and spacers on the shaft. Torque the nut to a minimum of 60 ft.lbs. Check that all of the tine rows are tight by attempting to move them by hand.
8. Reinstall the tine reel per the TINE REEL REMOVAL instructions above.
9. Re set the tension on the chain.
10. Replace the guard and reinstall the four screws that secure it in place.

REPLACING INDIVIDUAL TINES

1. Wait for engine to cool and disconnect spark plug.
2. Loosen but do not remove the outermost nut and carriage bolt that secure the damaged or worn tine.
3. Loosen and remove the innermost nut and carriage bolt that hold the tine in the reel.
4. Use a small prybar and push the tine plates apart slightly to slide out the tine to be replaced.
5. Slide the new tine in place and secure with the innermost nut and carriage bolt. Tighten completely.
6. Retighten the outermost nut and carriage bolt to completely secure the new tine.
7. Repeat as required to replace all damaged or worn tines.

NOTE: Tines are a normal wear item and should be inspected regularly for signs of wear or damage.

BELT AND CHAIN TENSION ADJUSTMENT

ADJUSTING BELT TENSION-

1. Remove the top guard (item 3) by removing the four screws (item 13), two on each side, that secure it to the frame.
2. Locate the top of the belt idler assembly where the clutch cable (item 55) is secured in place. A properly tensioned belt should stretch the idler spring (located next to the idler pulley) between 1/4" - 3/8" when the clutch bail (item 54) is held in the drive position.
3. Using a 1/2" wrench loosen the two nuts that secure the cable (item 55) in place.
4. TO INCREASE belt tension adjust these two nuts so that the cable (item 55) is secured in place with an additional 1/4" of the threaded adjuster at the top of the assembly.
TO DECREASE belt tension adjust these two nuts so that the cable (item 55) is secured in place with 1/4" less of the threaded adjuster at the top of the assembly.
5. Replace the guard (item 3) and reinstall the four screws (item 13) that secure it in place.
6. Run the unit to test your adjustment. Repeat as necessary to achieve proper adjustment. A properly adjusted belt will pull the unit up a 15 degree slope when clutched without any belt slip, and will declutch and stop the unit completely when the clutch is released.

 **NOTE:** Never release the clutch on a slope. The unit is heavy and will free wheel down hill.

NOTE: A worn belt will not allow for proper adjustment and must be replaced.

ADJUSTING CHAIN TENSION-

1. Remove the top guard (item 3) by removing the four screws (item 13), two on each side, that secure it to the frame.
2. Locate the bolt (item 31, 33) and nut (item 80) that hold each idler sprocket to the frame of the unit. One idler sprocket sets tension on the wheel drive chain and one sets tension on the tine drive chain.
3. Loosen the bolt and nut and slide the idler sprocket (item 29) in the desired direction.

INCREASED TENSION: Slide the sprocket to the rear.

DECREASED TENSION: Slide the idler sprocket to the front.

4. Tighten the bolt and nut to secure the sprocket in place.
5. Replace the guard and reinstall the four screws that secure it in place.

NOTE: Over tensioning the chain will cause premature chain and sprocket wear. **DO NOT OVER TENSION THE CHAIN.** A properly tensioned chain will have slack of 1/4"-3/8" when moved by hand.

DRIVE BELT REPLACEMENT

1. Wait for engine to cool and disconnect spark plug.
2. Remove the top guard by removing the four screws, two on each side, that secure it to the frame.
3. Slide the belt off of the engine drive pulley, and off of the jackshaft drive pulley.
4. Continue sliding the belt along the jackshaft to the right jackshaft bearing away from the pulley and sprockets.
5. Using a 9/16" wrench, remove the two bolts and nuts that hold the jackshaft bearing in place.
6. Carefully lift the jackshaft up until the belt can be slid out underneath the bearing.
7. Slide the new belt in place over the jackshaft.
8. Replace and tighten the bolts and nuts holding the jackshaft bearing in place. Be sure that the jackshaft is aligned straight across between both bearings.
9. Slide the belt along the jackshaft and over both engine and jackshaft pulleys. Be sure the idler pulley is positioned on the flat side of the belt.
10. Check proper belt tension. See BELT TENSION ADJUSTMENT in this manual.

CHAIN REPLACEMENT

NOTE: This procedure will work to change the wheel drive chain or the tine drive chain.

1. Wait for engine to cool and disconnect spark plug.
2. Remove the top guard by removing the four screws, two on each side, that secure it to the frame.
3. Roll the unit until the master link of the chain that you want to replace is exposed near the jackshaft sprocket.
4. Release the tension on the chain. See CHAIN TENSION ADJUSTMENT in this manual.
5. Using a screwdriver or similar device remove the spring clip that secures the master link in the chain.
6. With the master link removed unwind the chain from the two sprockets that it connects.
7. Carefully string the replacement chain around the same two sprockets and reconnect it with the new master link provided with your replacement chain.
8. Re set the tension on the chain.
9. Replace the guard and reinstall the four screws that secure it in place.

ENGINE MUST BE LEVEL WHEN CHECKING OR FILLING OIL

Maintenance Operation	Follow these hourly maintenance intervals.		
	Every Use (Daily)	Every 25 hrs	
Engine (See Engine Manual)			
Check engine oil	●		
Check gear reduction oil level		●	
Grease bearings (See Lubrication)			●
Oil chains (See Lubrication)		●	
Inspect for loose, worn, or damaged parts		●	
Thoroughly clean all debris from unit and tine reel.	●		
Inspect belt			●
Lubricate caster rigs			●

Problem	Possible Cause	Solution
Engine stalls or labors when aerating.	Working on too steep a slope. Not enough oil in the engine.	Work at 45 degrees to the slope moving up and down instead of across. Check and add engine oil.
Abnormal vibration.	Damaged or missing tines. Loose handle bolts. Loose engine bolts	Stop work immediately. Replace any damaged or missing tines. Tighten all loose bolts and nuts.
Engine will not start.	Stop switch off (Honda only). Throttle in off position. Engine not in full choke position. Out of gasoline. Bad or old gasoline. Spark Plug wire disconnected. Dirty air cleaner. Engine oil level too low (Honda only).	Check stop switches, throttle, choke position and gasoline. Connect spark plug wire. Clean or replace air cleaner. Check and fill engine oil. Contact a qualified service person.
Engine is locked, will not pull over.	Debris locked against reel, or drive pulleys. Engine problem.	Pull spark plug wire and remove debris. Contact an engine servicing dealer for engine problems.
Engine is making loud noise or squealing.	Gear reduction oil level is low.	Check and add oil according to engine owners manual.
Unit does not move when clutch is engaged.	Belt drive out of adjustment. Work drive belt. Loose or damaged chain or sprockets. Loose or damaged pulleys. Damaged or broken clutch cable.	See maintenance on page 7 of this manual. Contact a qualified servicing dealer.

ENGINE

ENGINE	HORSEPOWER	MODEL NO.	GOVERNED RPM
BRIGGS & STRATTON	5.5	127452-0049-E1	3600
HONDA	5.5	GX160K1HX2	3600

When servicing the engine refer to specific manufacturers engine owner's manual. All engine warranty is covered by the specific engine manufacturer. If your engine requires warranty or other repair work contact your local servicing engine dealer. When contacting a dealer for service it is a good idea to have your engine model number available for reference(See table page above). If you can not locate a servicing dealer in your area you can contact the manufacturers national service organization.

To contact:

Briggs & Stratton: 800-233-3723
American Honda: 800-426-7701

LUBRICATION

BEARINGS-

1. Remove the top guard by removing the four screws, two on each side, that secure it to the frame. NOTE: Guard must be removed to lubricate the jackshaft bearings only. All other bearings can be lubed without removing the guard.
2. Lubricate all 6 bearings using a pressurized grease gun with a standard lithium based grease.
3. Wipe any excess grease off of all bearings and fittings after each lubrication.
4. Replace the guard and reinstall the four screws that secure it in place.

CHAINS-

1. Remove the top guard by removing the four screws, two on each side, that secure it to the frame.
2. Apply a light coat of No. 30 Oil or a penetrating chain lubricant to keep the chain clean and in good running order.
3. Replace the guard and reinstall the four screws that secure it in place.

CASTERS-

1. Lubricate both caster rig bearings using a pressurized grease gun with a standard lithium based grease.
2. Wipe any excess grease off of all bearings and fittings after each lubrication.

22.1

Engine Service and Warranty
 Contact your nearest engine manufacturer's authorized servicing dealer. (See above)

21

Serial Plate Record your machine model, serial number and date-of-purchase and where purchased



1803 S. Jefferson
Lee's Summit,
MO 64062 / USA
Tel (816) 524-9666
Fax (816) 524-6983



Model

Serial No.

Unit(Weight)

 lbs. kg

Engine Power

 kW rpm



101 dB

Purchase Date _____ **Purchased from** _____

22

WARRANTY PROCEDURE

Please fill in the WARRANTY CARD and send the upper part to Billy Goat. The WARRANTY terms are stated on the lower part which remains with the user. Whenever a Billy Goat Machine is faulty due to a defect in material and / or workmanship, the owner should make a warranty claim as follows:

The Machine should be taken to the dealer from whom it was purchased or to an authorized Billy Goat dealer.

The owner should present the remaining half of the Warranty Registration Card, or, if this is not available, the invoice or receipt.

The Warranty Claim will be filled in by the authorized Billy Goat Dealer, who will send it with the faulty part to Billy Goat headquarters.

The Quality / Service department at Billy Goat headquarters will study the claim and parts and will notify their conclusions.

The decision by the Quality / Service department at Billy Goat headquarters to approve or reject a Warranty claim is final and binding.

Note: To process a Warranty Claim, it is necessary to quote the Model & Serial number who are printed on the Billy Goat Serial Plate.



BILLY GOAT INDUSTRIES INC.
 1803 S.W. JEFFERSON / LEE'S SUMMIT, MO 64082-2312 / USA
 PHONE: 816-524-9666 FAX: 816-524-6983 www.billygoat.com