

BILLY GOAT TRUCK LOADER VACUUM Owner's Manual

HTR1803V, TR1304H, TR1104

Accessories

INTAKE

EXHAUST

HOSE COUPLER KIT 8" (203mm) TR	HOSE CONNECTOR KIT 8" (203mm) TR & 10" (254mm) HTR	EXHAUST EXTENSION KIT	EXHAUST HOSE KIT	EXHAUST HOSE COUPLER KIT	EXHAUST HOSE CONNECTOR KIT	PANEL FILTER KIT	PORTABLE DEBRIS BAG
Quick release coupler joins 2 hoses together to increase vacuuming distance and allows hoses to be separated for storage.	For permanently connecting 2 hoses together to increase vacuuming distance.	Increases exhaust height 11"(280mm) for loading debris into elevated locations.	[6"(152mm) x 10' (3.0m)] Quick release coupler and hose increases exhaust distance.	<i>Quick release coupler joins 2 hoses together to increase exhaust distance and allows hoses to be separated for storage.</i>	[6"(152mm)] Permanently joins 2 exhaust hoses together to increase exhaust distance.	Provides air filter panel for use on truck and trailer mounted debris enclosures.	1.3 yds.3 (1.0m ³) or 28.4 bushels (1000L). For portable use. Several bags can be filled and left for later pickup.
P/N 810525	P/N 810524 & 810776	P/N 810637	P/N 811206	P/N 811207	P/N 800336	P/N 810584	P/N 810660



ABOUT THIS MANUAL

THANK YOU for purchasing a BILLY GOAT® *TR/HTR Vacuum*. Your new machine has been carefully designed and manufactured to provide years of reliable and productive service. This manual provides complete operating and maintenance instructions that will help to maintain your machine in top running order. Read this manual carefully before assembling, operating, or servicing your equipment.

CONTENTS

SERIAL PLATE DATA AND SPECIFICATIONS _____	3
GENERAL SAFETY _____	4-5
SOUND AND VIBRATION _____	6
INSTRUCTION LABELS _____	7
PACKING CHECKLIST & ASSEMBLY _____	8-9
OPERATION _____	9-10
MAINTENANCE _____	11
TROUBLESHOOTING AND WARRANTY PROCEDURE _____	12
MAINTENANCE RECORD _____	13
ILLUSTRATED PARTS & PARTS LISTS _____	14-16



SERIAL PLATE DATA

Record the model number, serial number, date of purchase, and where purchased.

Purchase Date: _____

Purchased From: _____

1803 S.W. Jefferson
Lee's Summit,
MO 64082 / USA
Tel (816) 524-9666
Fax (816) 524-6983

Model: _____ Serial No.: _____

Unit (Weight): _____ lbs. _____ kg Engine Power: _____ kW _____ rpm

Specifications

	HTR1803V	TR1304H	TR1104
Engine: HP	18 (13.4 kW)	12 (10.68 kW)	11 (9.04 kW)
Engine: Model	3564420186EI	GX390U1QA2	2104320125E1
Engine: Type	BRIGGS & STRATTON	HONDA	BRIGGS & STRATTON
Engine: Fuel Capacity	9qt. (8.52 L)	6.9 qt. (6.0 L)	4.0 qt (3.8 L)
Engine: Oil Capacity	1.75 qt. (1.66 L)	1.16 qt. (1.1 L)	0.875 qt. (0.8 L)
Total Unit Weight:	274# (124.3 kg)	240# (108.0 kg)	224# (101.6 kg)
Max operating slope	20 ⁰	20 ⁰	20 ⁰
Sound in accordance with 2000/14/EEC standards	121 dB(a)	121 dB(a)	121 dB(a)
Sound at operators ear	105 dB(a)	105 dB(a)	105 dB(a)
Vibration at operator position	0.02g	0.02g	0.02g



GENERAL SAFETY INSTRUCTIONS and SYMBOLS

The safety symbols shown below are used throughout this manual. You should become familiar with them before assembling, operating, or servicing this equipment.



WARNING: This symbol indicates important information that will prevent injury to yourself or others.



This symbol indicates ear protection is recommended when operating this equipment.



This symbol indicates eye protection is recommended when operating this equipment.



This symbol indicates gloves should be worn when servicing this equipment.



This symbol indicates that this manual and the engine manufacturer's manual should be read carefully before assembling, operation, or servicing this equipment.



CAUTION: This symbol indicates important information that will prevent damage to your BILLY GOAT® HTR/TR VACUUM.



This symbol indicates the engine oil level should be checked before operating this equipment.

Read and make sure you thoroughly understand the following safety precautions before assembling, operating or servicing this equipment:



READ this manual and the engine manufacturer's manual carefully before assembling, operating, or servicing this equipment.



EAR PROTECTION is recommended when operating this equipment.



EYE PROTECTION is recommended when operating this equipment.



BREATHING PROTECTION is recommended when operating this equipment.





















WARNING: **EXHAUST** from this product contains chemicals known to the State of California to cause cancer, birth defects or other reproductive harm.

DO NOT operate this equipment on any unimproved forested, brushy, or grass covered land unless a spark arrester is installed on the muffler as required by Section 4442 of the California Public Resources Code. The arrester must be maintained in good working order. Other states may have similar laws. Federal laws apply on federal lands.

DO NOT run engine in an enclosed area. Exhaust gases contain carbon monoxide, an odorless and possibly fatal poison.







WARNING:

-  **DO NOT** run this equipment indoors or in any poorly ventilated area. Refueling outdoors is recommended.
-  **DO NOT** refuel this equipment while the engine is running. Allow engine to cool for at least two minutes before refueling.
-  **DO NOT** store gasoline near an open flame.
-  **DO NOT** remove gas cap while engine is running.
-  **DO NOT** start or operate engine if strong odor of gasoline is present.
-  **DO NOT** start or operate engine if gasoline is spilled. Move equipment away from spill until gasoline has completely evaporated.
-  **DO NOT** smoke while filling the fuel tank.
-  **DO NOT** check for spark with spark plug or spark plug wire removed. Use an approved spark tester.
-  **DO NOT** operate engine without a muffler. Inspect muffler periodically and replace if necessary. If equipped with muffler deflector, inspect deflector periodically and replace if necessary.
-  **DO NOT** operate engine with grass, leaves or other combustible material near the muffler.
-  **DO NOT** touch muffler, cylinder, or cooling fins when hot. Contact with hot surfaces may cause severe burns.
-  **DO NOT** leave equipment unattended while in operation.
-  **DO NOT** operate equipment with bystanders in or near the work area.
-  **DO NOT** allow children to operate this equipment.
-  **DO NOT** operate equipment with guards removed.
-  **DO NOT** operate equipment near or pick up hot or burning debris or any toxic or explosive materials.
-  **DO NOT** operate equipment on slopes greater than specified in Specifications section of this manual.
-  **DO NOT** start engine without height adjust lever in up position and clutch bail disengaged.
-  **DO NOT** place hands or feet inside nozzle intake, near debris outlet, or near any moving parts.



WARNING: Important

DO NOT use this machine for vacuuming **exclusively** sand, dust, fine dirt, rock, glass, string like material, grain, rags, cans, metal, bark or water.

-  **DO NOT** start engine without hose and exhaust elbow connected firmly in place to housing and outlet.
-  **DO NOT** operate without discharging exhaust into enclosed container.
-  **DO NOT** operate with hose or exhaust elbow removed
-  **DO NOT** remove hose until engine has been turned off and has come to a complete stop.

ALWAYS remove spark plug wire when servicing equipment to prevent accidental starting.

ALWAYS check fuel lines and fittings frequently for cracks or leaks. Replace if necessary.

ALWAYS keep hands and feet away from moving or rotating parts.

ALWAYS store fuel in approved safety containers.



HTR/TR Owner's Manual

SOUND



L_{wA} SOUND LEVEL 105 dB(a) at Operator Position
121 dB

Sound tests were conducted in accordance with 2000/14/EEC, and were performed on 5-28-2002 under the conditions listed below.

⚠ Sound power level listed is the highest value for any model covered in this manual. Please refer to serial plate on the unit for the sound power level for your model.

General Conditions:	Sunny
Temperature:	45°F (7.2°C)
Wind Speed:	5 mph (8.1 kmh)
Wind Direction:	South West
Humidity:	60%
Barometric Pressure:	30.18Hg (767 mm Hg)

VIBRATION DATA

VIBRATION LEVEL 0.02g

Vibration levels at the operator's handles were measured in the vertical, lateral and longitudinal directions using calibrated vibration test equipment. Tests were performed on 7-14-94 under the conditions listed below.

General Conditions:	Sunny
Temperature:	78°F (23.8°C)
Wind Speed:	16 mph (25.7kmh)
Wind Direction:	South East
Humidity:	62%
Barometric Pressure:	30.1"Hg (765mm Hg)

INTENDED USE

INTENDED USE: This machine is designed for vacuuming leaves, grass clippings and other types of organic litter. Debris mixed with cans, bottles and small amounts of sand can be vacuumed; however, it is not this machine's primary purpose. Vacuuming cans, bottles and sand will affect the longevity of your machine.

Do not operate if excessive vibration occurs. If excessive vibration occurs, shut engine off immediately and check for damaged or worn impeller, loose impeller bolt, loose impeller key, loose engine or lodged foreign objects. Note: For proper impeller bolt torque specifications. (See impeller removal section on page 11).

INSTRUCTION LABELS

The labels shown below were installed on your BILLY GOAT® TR/HTR Vacuum. If any labels are damaged or missing, replace them before operating this equipment. Item numbers from the Illustrated Parts List and part numbers are provided for convenience in ordering replacement labels. The correct position for each label may be determined by referring to the Figure and Item numbers shown.



LABEL DANGER KEEP HANDS AND FEET AWAY
ITEM #3 P/N 400424



LABEL EAR EYE BREATHING
ITEM# 48 P/N 830503



LABEL ENGINE OVERHEAT
ITEM#49 P/N 811215



DANGER FLYING DEBRIS
ITEM #19 P/N 810736



LABEL READ OWNERS MANUAL
ITEM #15 P/N 830301



LABEL EXPLOSIVE FUEL
ITEM # 81 P/N 400268



LABEL CAUTION
ITEM #47 P/N 830138

ENGINE LABELS

BRIGGS & STRATTON (VANGUARD)



HONDA

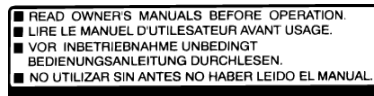

BRIGGS AND STRATTON

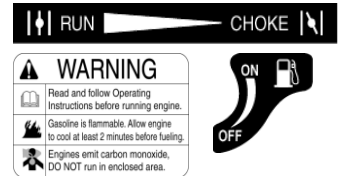

THROTTLE CONTROLS

TR Units have frame mounted throttle controls as shown here.

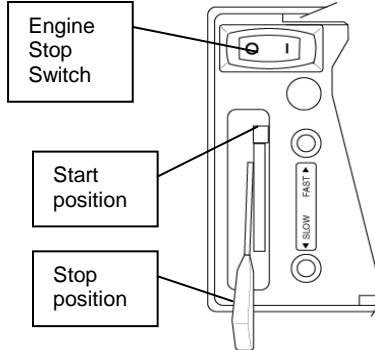

Briggs Vanguard Units have an engine mounted throttle control.



PACKING CHECKLIST

Your Billy Goat is shipped from the factory in one carton and is completely assembled except for the exhaust elbow, nozzle, handle loop for nozzle, hose booms, hose bands, hose coupler, hose clamps and related hardware.



READ all safety instructions before assembling unit.
TAKE CAUTION when removing the unit from the box.



PUT OIL IN ENGINE BEFORE STARTING

PARTS BAG & LITERATURE ASSY

Warranty card P/N- 400972, Owner's Manual P/N-811202, Declaration of Conformity P/N-811204, Literature HTR/TR Accessories 811208.

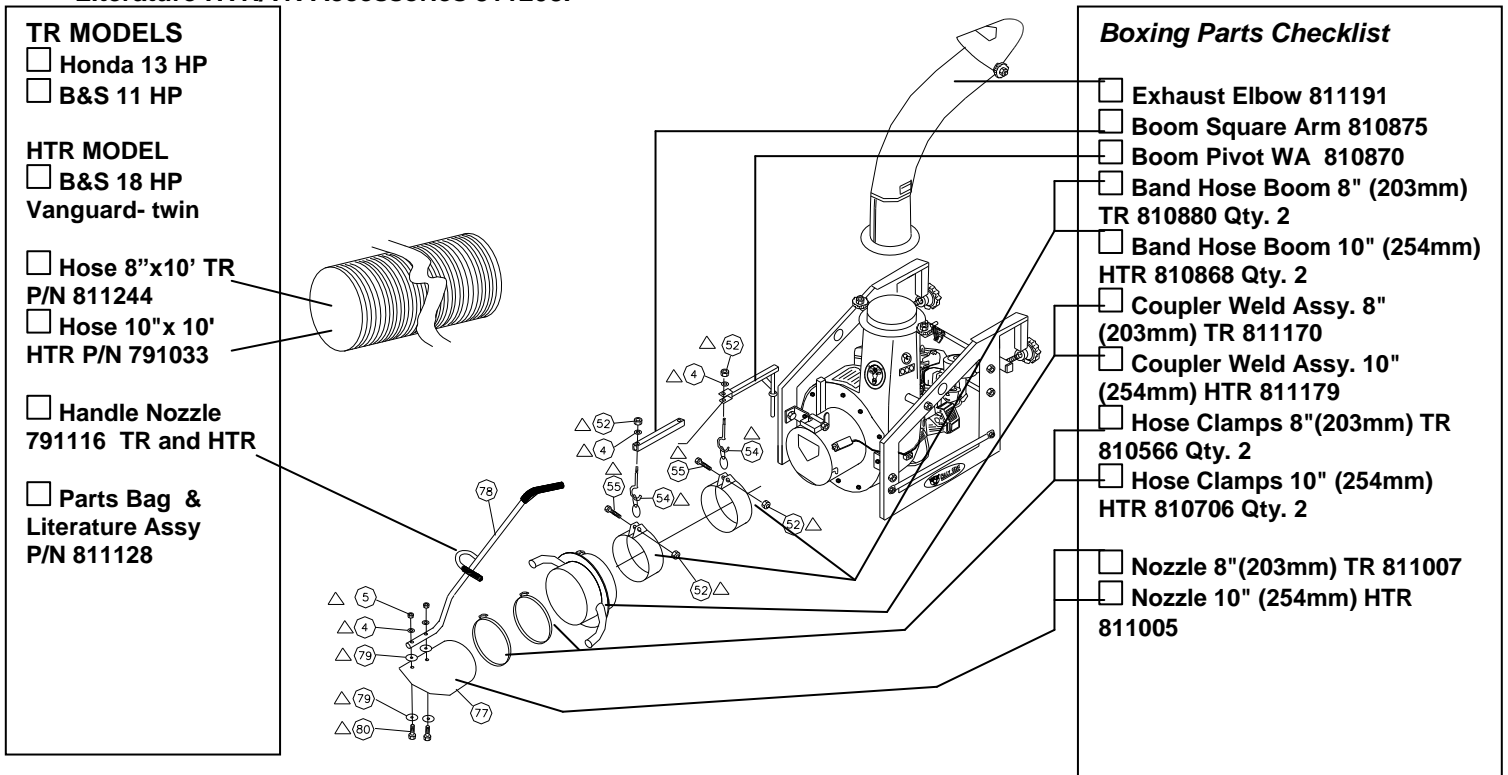

Parts Bag Hardware

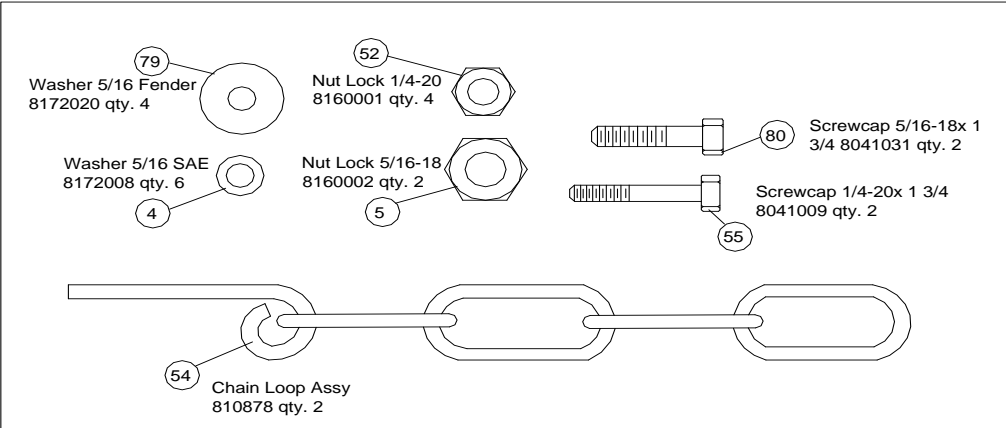



ASSEMBLY

1. **ASSEMBLE** exhaust elbow (item 10), to main unit and firmly tighten knobs (item 90), that are preassembled to main unit.
2. **SECURELY ATTACH** unit to tailgate of a truck or to a trailer, so that the exhaust discharges into an enclosed container.
3. **ATTACH** hose to hose coupler (item 24), using hose clamp (item 60)
4. **ASSEMBLE** hose coupler to housing of main unit and securely tighten knob (item 13), that is preassembled to housing front plate.
5. **ASSEMBLE** nozzle handle loop (item 82), to nozzle handle using screw (item 80), washer (item 6) and lock nut (item 5). Adjust handle loop to desired height and angle and securely tighten in place.
6. **ASSEMBLE** nozzle handle (item 78), to nozzle (item 77), using screws (item 80), washers (item 79), washers (item 4) and lock nuts (item 5).
7. **ATTACH** assembled nozzle to hose using hose clamp (item 60). Before tightening hose clamp, position nozzle handle upward when hose is stretched to prevent twisting load on hose assembly during operation.
8. **ASSEMBLE** tube square boom (item 51), to boom pivot (item 50), using chain loop assembly (item 54), washers (item 4) and lock nut (item 52).
9. **ASSEMBLE** remaining chain loop assembly (item 54), to end of tube square boom (item 51) using washer (item 4) and lock nut (item 52).
10. **SLIDE** boom assembly into square tube on front of housing.
11. **ASSEMBLE** hose bands (item 56) around hose and onto chain loop assemblies on boom assembly using screws (item 55) and lock nuts (item 52) (see ADJUSTING HOSE BOOM on page 10).

OPERATION

 Like all mechanical tools, reasonable care must be used when operating machine.

Inspect machine work area and machine before operating. Make sure that all operators of this equipment are trained in general machine use and safety.

 **PUT OIL IN ENGINE BEFORE STARTING**

STARTING

SECURE LOADER TO TAILGATE OR MOUNTING

 **ENGINE:** See engine manufacturer's instructions for type and amount of oil and gasoline used. Engine must be level when checking and filling oil and gasoline.

ENGINE SPEED: Controlled by throttle lever on the frame (18HP Twin on engine). Under normal conditions, operate at minimum throttle to accomplish your current cleaning task.

FUEL VALVE: Move fuel valve to "ON" position (when provided on engine).

INTAKE HOSE: Must be attached to front plate to start engine.

CHOKE: Located on engine near engine throttle panel.

STOP SWITCH: Move to on position (when provided).

THROTTLE: Move remote throttle control to fast position. Pull starting rope to start engine.

IF YOUR UNIT FAILS TO START:

See Troubleshooting on page 12.

HANDLING & TRANSPORTING:



ALWAYS REMOVE LOADER FROM TAILGATE OR MOUNTING BEFORE TRANSPORTING OR OPENING

TAILGATE. Using two people to lift machine is recommended. Lift holding the rear handle and front of frame. Secure in place during transport. See page 3 for weight specifications.

HOSE: DO NOT drag the hose with vehicle.



Never lift the machine while the engine is running.



VACUUMING OPERATION

EXHAUST FLAPPER: Discharging into enclosed container, position exhaust flapper to desired opening and secure adjustment knob before starting engine. **NOTE:** An enclosed container must capture all debris delivered into it preventing any debris from blowing back onto unit's engine (see page 1 optional accessories).

NOZZLE: With machine running and fully assembled, move nozzle in sweeping motions over debris. For maximum pickup, move nozzle close to debris, but without blocking airflow into the nozzle (see figure 1). **NOTE:** Never bury nozzle into debris.

HOSE OPERATION TIPS

THE HOSE IS A REPLACEABLE WEAR ITEM.

FOR BEST HOSE OPERATION RESULTS, FOLLOW THESE RECOMMENDATIONS.

Keep hose as straight as possible during operation for best pick-up and to avoid clogs.

Avoid sharp bends in hose, which will reduce efficiency and may promote clogs.

NEVER DRAG HOSE. Always remove and store hose before transporting unit.

ADJUSTING HOSE BOOM

Properly adjusting the boom will prevent most hose clogs from occurring and will give optimum vacuum performance by keeping hose straight next to housing (see fig. 2).

UNCLOGGING A CLOGGED HOSE

With engine running and unit secured to tailgate, fully stretch hose in a straight line to dislodge the clog. If the clog will not clear, turn unit off, and allow engine to come to a complete stop. Remove hose and manually clear hose clog.

UNCLOGGING A CLOGGED HOUSING OR EXHAUST ELBOW

Turn engine off and wait for impeller to come to a complete stop. Disconnect spark plug wire. **Danger**, the clog may contain sharp materials. Wearing durable gloves, clear the clog. Reconnect spark plug wire.

HOSE LIFE

To increase hose life, periodically rotate hose and reposition nozzle and coupler on front plate of unit. This increases hose life by keeping hose from wearing only on one side.

HEAVY DEBRIS REMOVAL

TILT NOZZLE FORWARD TO PICK UP DIFFICULT DEBRIS.

STORAGE

Turn fuel supply off when unit is not in use.

Never store engine indoors or in enclosed poorly ventilated areas with fuel in tank, where fuel fumes may reach an open flame, spark or pilot light, as on a furnace, water heater, clothes dryer or other gas appliance.

If engine is to be unused for 30 days or more, prepare as follows:

Be sure engine is cool. Do not smoke. Remove all gasoline from carburetor and fuel tank to prevent gum deposits from forming on these parts and causing possible malfunction of engine. Drain fuel outdoors, into an approved container, away from open flame. Run engine until fuel tank is empty and engine runs out of gasoline.

NOTE: Fuel stabilizer (such as Sta-Bil) is an acceptable alternative in minimizing the formation of fuel gum deposits during storage. Add stabilizer to gasoline in fuel tank or storage container. Always follow mix ratio found on stabilizer container. Run engine at least 10 min. after adding stabilizer to allow it to reach the carburetor.

HOSE STORAGE: Storing hose in a covered area, out of sunlight and heat will prolong hose life. Do not store hose where it could be stepped on or where other objects could crush or damage hose.

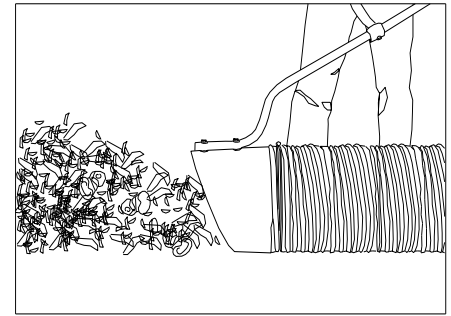

Fig. 1

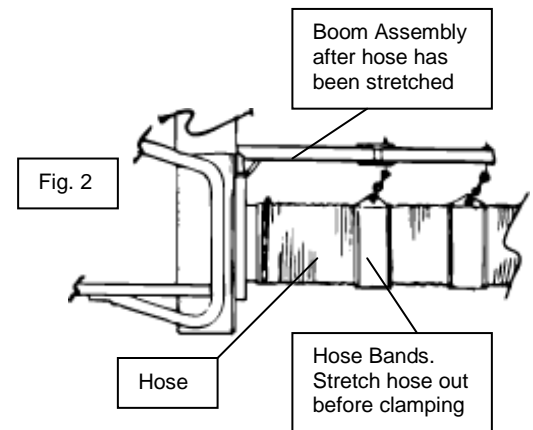

Fig. 2



Fig. 3

MAINTENANCE

PERIODIC MAINTENANCE

Periodic maintenance should be performed at the following intervals:

Maintenance Operation	Every use	Every 5 hours (daily)	Every 25 Hours
Inspect for loose, worn or damaged parts.		●	
Check engine oil and air filter	●		
Clean hose	●		
Engine (See Engine Manual)			
Grease Exhaust Ring (see A pg. 14)			●
Keep engine free of debris	●		
Check for excessive vibration		●	

IMPELLER REMOVAL

1. Wait for engine to cool and disconnect spark plug.
2. Disconnect hose from unit.
3. Remove boom assembly.
4. Remove cable assy. interlock (item 43), from front plate of assembly (item 41).
5. Remove front plate assembly (item 41).
6. Remove impeller bolt (item 16) and lock washer (item 17).
7. Pull the impeller outward. If impeller slides freely, proceed to (steps 10 to 14 for TR units or to step 14 for HTR units). If not, complete steps 8 thru 9 as required.
8. Place two crowbars between impeller and housing on opposite sides. Pry impeller away from engine until it loosens. *Using a penetrating oil can help loosen a stuck impeller.*
9. If the impeller does not loosen, obtain a 1" (25.4mm) longer bolt of the same diameter and thread type as the impeller bolt. Thread longer bolt by hand into the crankshaft until bolt bottoms. Using a suitable gear or wheel puller against the bolt head and the impeller back-plate (near the blades), remove impeller from shaft.
10. **[TR ONLY]** Remove engine base mounting bolts, and nuts.
11. **[TR ONLY]** Access engine bolts on inside of housing that connect engine face to the fan housing. Bend ends of lock clip away from bolt heads and remove bolts.
12. **[TR ONLY]** Slide engine shaft out of impeller.
13. **[TR ONLY]** When impeller is free of the engine shaft, align impeller with opening, and diagonally lift impeller out of housing.
14. Using a new impeller bolt and lockwasher (and engine bolt lock clip, TR only), reinstall (engine for TR only) and new impeller in reverse order.
15. Tighten impeller bolt. Torque HTR1803V and TR1304H impeller bolt to [33-38 Ft. Lbs. (45-52 N.m)] and TR1104 to [55-60 Ft. Lbs. (75-81 N.m)] (see item 16 on page 15).
16. Reinstall spark plug wire.

INTERLOCK SYSTEM

With hose coupler installed (as shown in Fig. 4) the switch is open & engine is not grounded out, allowing engine to run.

HTR1803V SYSTEM

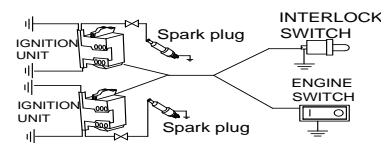

TR1104 SYSTEM

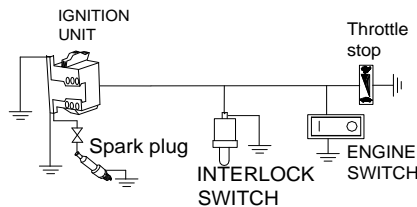
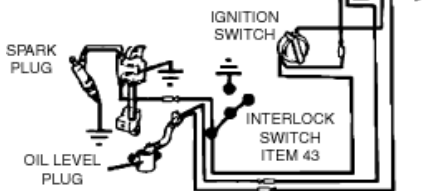

Fig. 3

TR1304H SYSTEM



Part No 811202

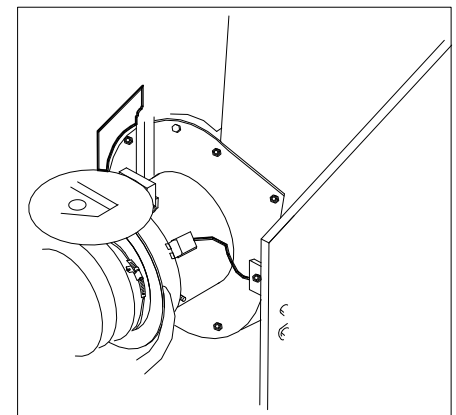

Fig. 4

Form No F111207A



Troubleshooting

Problem	Possible Cause	Solution
Abnormal vibration.	Loose or out of balance impeller or loose engine	· Stop work immediately. Check impeller and replace if required. Check engine and tighten all loose nuts and bolts.
Will not vacuum or has poor vacuum performance	· Nozzle height too high or low. Clogged hose or exhaust. Excessive quantity of debris.	· Adjust nozzle position. Unclog hose or exhaust (see pg. 10) Allow air to feed debris.
Engine will not start.	· Throttle & / or stop switch in off position. Out of gasoline. Bad or old gasoline. Spark plug wire disconnected. Dirty air cleaner. Hose not installed, allowing interlock wire to ground.	· Check stop switches, throttle, and gasoline. Connect spark plug wire. Clean or replace air cleaner. Or contact a qualified service person. Install hose onto housing.
Engine is locked, will not pull over.	· Debris locked against impeller. Engine problem.	· See pg.10, Clearing a clogged impeller housing. Contact an engine servicing dealer for engine problems.

When servicing engine refer to specific manufacturers engine owner's manual. Engine warranty is covered by the specific engine manufacturer. If your engine requires warranty or other repair work contact your local servicing engine dealer. When contacting a dealer for service it is a good idea to have your engine model number available for reference (See table page 3). If you cannot locate a servicing dealer in your area you can contact the manufacturers national service organization.

To reach:

American Honda: 800-426-7701

Briggs & Stratton: 800-233-3723

WARRANTY CLAIM PROCEDURE

Should a BILLY GOAT[®] machine fail due to a defect in material and/or workmanship, the owner should make a warranty claim as follows:

- The machine must be taken to the dealer from whom it was purchased or to an authorized Servicing BILLY GOAT Dealer.
- The owner must present the remaining half of the Warranty Registration Card, or, if this is not available, the invoice or receipt.
- The Warranty Claim will be completed by the authorized BILLY GOAT Dealer and submitted to their respective BILLY GOAT Distributor for their territory Attention: Service Manager. Any parts replaced under warranty must be tagged and retained for 90 days. The model number and serial number of the unit must be stated in the Warranty Claim.
- The distributor service manager will sign off on the claim and submit it to BILLY GOAT for consideration.
- The Technical Service Department at BILLY GOAT will study the claim and may request parts to be returned for examination. BILLY GOAT will notify their conclusions to the distributor service manager from whom the claim was received.
- The decision by the Technical Service Department at BILLY GOAT to approve or reject a Warranty Claim is final and binding.

For online product registration go to www.billygoat.com



PARTS DRAWING HTR/TR

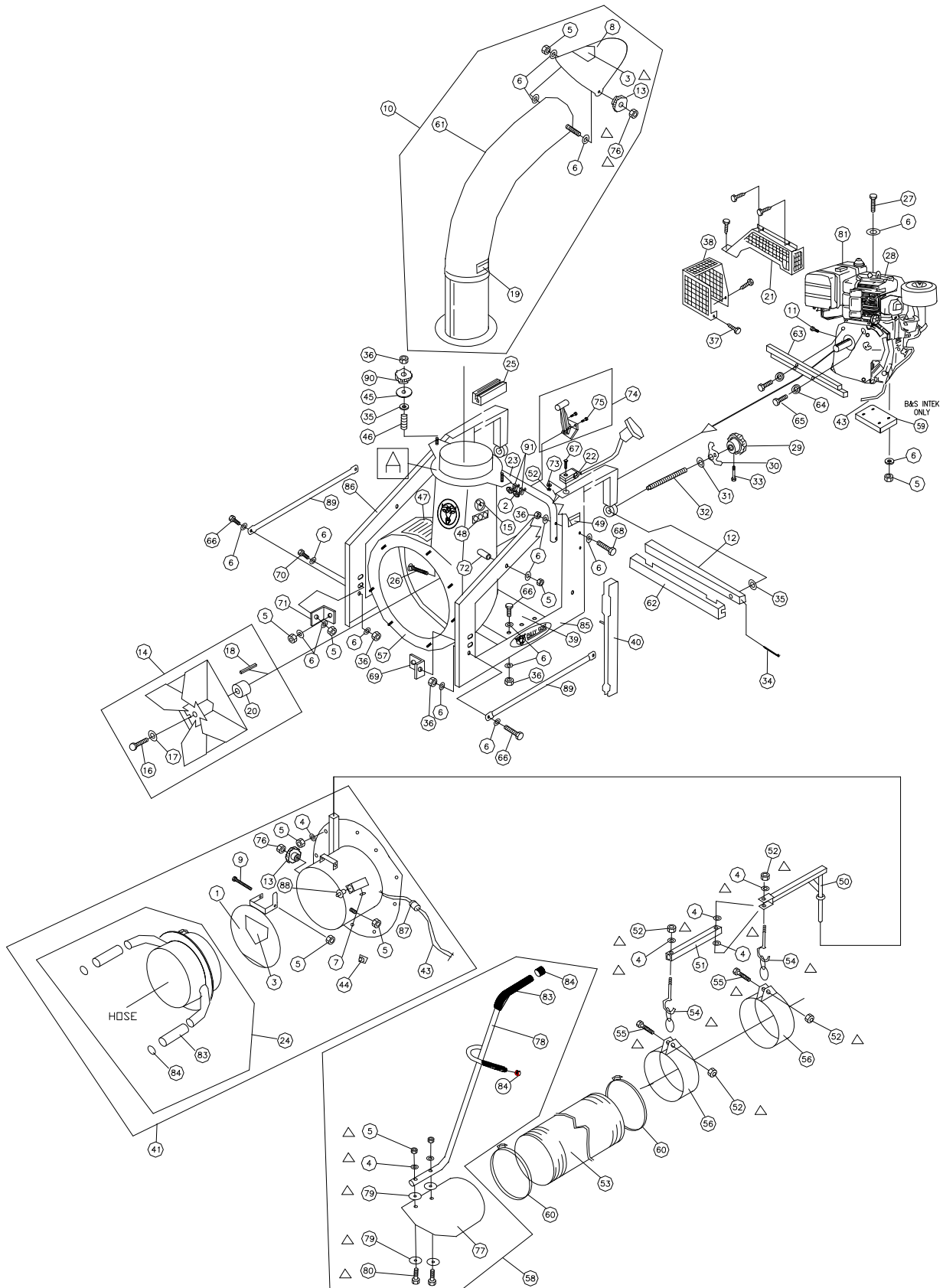



PARTS LIST

ITEM	DESCRIPTION	HTR1803V PART NO.	QTY	TR1304H PART NO.	QTY	TR1104 PART NO.	QTY
1	FLAPPER 10" INTAKE W/LABEL	811183	1	- - -	- - -	- - -	- -
	FLAPPER 8" INTAKE W/LABEL	- - -	- -	811174	1	811174	1
2	NUT LOCK 10-24	-	-	8164005	2	8164005	2
3	LABEL DANGER KEEP HANDS AND FEET AWAY	400424	2	400424	2	400424	2
4	WASHER 5/16 SAE (11/32 ID x 11/16 OD x 1/16)	*8172008	12	*8172008	10	*8172008	10
5	NUT LOCK 5/16-18	*8160002	18	*8160002	18	*8160002	18
6	WASHER 5/16 FLAT CUT (3/8 I.D. x 7/8 O.D. x 1/16)	*8171003	44	*8171003	44	*8171003	44
7	PLUG 3/4"	811123	1	811123	1	811123	1
8	DEFLECTOR EXHAUST 7"	811111	1	811111	1	811111	1
9	CARRIAGE BOLT 5/16-18 x 3 1/2	*8024050	1	*8024050	1	*8024050	1
10	ELBOW ASSY TR/HTR	811191	1	811191	1	811191	1
11	SCREWCAP 5/16-18X.75					8041026	1
12	TUBE CLAMP	810953	1	810953	1	810953	1
13	KNOB	400339	2	400339	2	400339	2
14	IMPELLER ASSY (INCLUDES 16(1),17(1),18(1), 20(1))	810930	1	810974	1	810629	1
15	LABEL READ OWNER'S MANUAL	890301	1	890301	1	890301	1
16	SCREW CAP 3/8-24 x 2" GR 8 [33-38 Ft. Lbs. (45-52 N.m)]	810962	1	- - -	- -	- - -	- -
	SCREW CAP 3/8 - 24 X 2 1/4 GR 8 [33-38 Ft. Lbs. (45-52 N.m)]	- - -	- -	810932	1	- - -	- -
	SCREW CAP 7/16 - 20 X 2 GR 5 [55-60 Ft. Lbs. (75-81 N.m)]	- - -	- -	- - -	- -	500188	1
17	WASHER LOCK 3/8 TWISTED TOOTH	400502	1	400502	1	- - -	- -
	WASHER LOCK 7/16 TWISTED TOOTH	- - -	- -	- - -	- -	850132	1
18	KEY SQ. 1/4 x 2 3/4	*9201125	1	*9201125	1	- - -	- -
	KEY SQ. 1/4 X 2 1/4	- - -	- -	- - -	- -	*9201123	1
19	LABEL DANGER FLYING MATERIAL	810736	2	810736	2	810736	2
20	SPACER IMPELLER	830112	1	830112	1	830112	1
21	GUARD MANIFOLD	811059	1	- - -	- -	- - -	- -
22	GUIDE STARTER ROPE (HALF)	830533	2	830533	2	830533	2
23	TUBE REAR FRAME	811218	1	811218	1	811218	1
24	COUPLER HOSE W/GRIP	811179	1	811170	1	811170	1
25	PAD FRAME SHORT	811120	2	811120	2	811120	2
26	CARRIAGE BOLT 5/16-18 x 2 1/4	*8024045	1	- - -	- -	- - -	- -
	CARRIAGE BOLT 5/16-18 x 4 1/2	- - -	- -	*8024054	1	*8024054	1
27	SCREW CAP 5/16-18 x 1 1/2	*8041030	4	*8041030	4	- - -	- -
	SCREW CAP 5/16-18 x 2 1/2	- - -	- -	- - -	- -	*8041034	4
28	ENGINE 18 H.P. V.N W/CONTROL PANEL	811224	1	- - -	- -	- - -	- -
	ENGINE HONDA 13HP	- - -	- -	430366	1	- - -	- -
	ENGINE BRIGGS 11 HP INTEK I/C	- - -	- -	- - -	- -	811205	1
29	KNOB	850154	2	850154	2	850154	2
30	NUT LOCK W.A.	800227	2	800227	2	800227	2
31	WASHER 3/4, PLASTIC	800109	2	800109	2	800109	2
32	STUD 3/4 -10 x 5 1/2	810954	2	810954	2	810954	2
33	SCREW MACHINE #10-24 x 2	*8059143	2	*8059143	2	*8059143	2
34	PIN COTTER 1/8 x 1"	*8197031	2	*8197031	2	*8197031	2
35	WASHER 3/8 SAE	*8172009	4	*8172009	4	*8172009	4
36	NUT LOCK 3/8-16	*8160003	18	*8160003	18	*8160003	18
37	SCREW SHEET METAL 1/4 AB x 3/4	*8122082	3	- - -	-	- - -	- -
38	GUARD MUFFLER	811058	1	- - -	-	- - -	- -
39	BASE ENGINE	810907	1	810907	1	810907	1
40	PAD FRAME LONG	811122	2	811122	2	811122	2
41	PLATE FRONT 10" HTR W/INTERLOCK (INCL. 1,2,3,5(2),7,13,43,44,49,59,83,84,8)	811182	1	- - -	-	- - -	-
	PLATE FRONT 8" TR W/INTERLOCK (INCL. 1,2,3,5(2),7,13,43,44,49,59,83,84,87,8)	- - -	- -	811173	1	811173	1
42							
43	CABLE ASSY SWITCH SV	890442	1	890442	1	890442	1
44	CLIP-CABLE LIFT	850200	3	850200	3	850200	3
45	WASHER-1.5 OD X 0.531 ID	610308-P	2	610308-P	2	610308-P	2
46	SPRING	400332	2	400332	2	400332	2
47	LABEL CAUTION	830138	1	830138	1	830138	1
48	LABEL EAR,EYE,BREATHING	890254	1	890254	1	890254	1
49	LABEL WARNING ENGINE OVERHEAT	811215	2	811215	2	811215	2
50	BOOM-PIVOT W.A.	810870	1	810870	1	810870	1
51	TUBE-SQUARE BOOM ARM	810875	1	810875	1	810875	1
52	NUT LOCK 1/4-20	*8160001	5	*8160001	5	*8160001	5
53	HOSE 10" x 10' HTR	791033	1	- - -	-	- - -	-
	HOSE 8" x 10' TR	- - -	-	811244	1	811244	1
54	CHAIN-LOOP ASSY	810878	2	810878	2	810878	2
55	SCREW CAP 1/4-20 x 1 3/4	*8041009	2	*8041009	2	*8041009	2
56	BAND HOSE BOOM 10" HTR	810868	2	- - -	-	- - -	-
	BAND HOSE BOOM 8" TR	- - -	-	810880	2	810880	2
57	HOUSING ASSY W/LABELS (INCLUDES 5(2), 13(2), 45(2), 46(2), 47, 48)	810912	1	810976	1	810976	1
58	NOZZLE ASSY 10" HTR (INCL. 4(2), 5(3), 6, 23, 77, 79(4), 80(2), 82, 83, 84)	811010	1	- - -	-	- - -	-
	NOZZLE ASSY 8" TR (INCL. 4(2), 5(3), 6, 23, 77, 79(4), 80(2), 82, 83, 84)	- - -	-	811009	1	811009	1
59	SPACER ENGINE INTEK	- - -	-	- - -	-	430355	1
60	CLAMP HOSE 10" HTR	810706	2	- - -	-	- - -	-
	CLAMP HOSE 8" TR	- - -	-	810566	2	810566	2
61	ELBOW EXHAUST WA	811192	1	811192	1	811192	1
62	PAD FRAME CLAMP TUBE	811121	1	811121	1	811121	1
63	SUPPORT PLATE ENGINE / SPACER ENG.	810927	1	810965	1	810965	1



HTR/TR Owner's Manual

PARTS LIST

ITEM	DESCRIPTION	HTR1803V PART NO.	QTY	TR1304H PART NO.	QTY	TR1104 PART NO.	QTY
64	WASHER LOCK 3/8	*8177012	2	*8177012	2	- - -	-
	WASHER LOCK 5/16 EXT. TOOTH	- - -	-	- - -	-	*8181008	2
65	SCREW CAP 3/8 - 16 X 1	*8041050	2	- - -	- -	- - -	- -
	SCREW CAP 3/8 - 16 X 1 1/2 ZP	- - -	- -	8041052	2	8041052	2
66	SCREW CAP 3/8 - 16 x 1"	*8041050	12	*8041050	12	*8041050	12
67	SCREW CAP 1/4-20 X 1 1/2	*8041008	1	*8041008	1	*8041008	1
68	SCREW CAP 3/8 - 16 X 1 3/4 ZP	*8041053	4	*8041053	4	*8041053	4
69	ANGLE BRKT R.H.	810917	1	811096	1	811096	1
70	SCREW CAP 5/16-18 x 1"	*8041028	2	*8041028	2	*8041028	2
71	ANGLE BRKT L.H.	810916	1	810969	1	810969	1
72	SPACER	811097	1	811098	1	811098	1
73	WASHER FLAT CUT 1/4	*8171002	1	*8171002	1	*8171002	1
74	CONTROL THROTTLE ASSY	810904-1	1	811222	1	811222	1
75	SCREW MACHINE 10-24 x 1-1/2"	- - -	- -	8059141	2	8059141	2
76	NUT LOCK 5/16-18 THIN HT.	8161041	2	8161041	2	8161041	2
77	NOZZLE FORMED STEEL 10"	811005	1	- - -	- -	- - -	- -
	NOZZLE FORMED STEEL 8"	-	-	811007	1	811007	1
78	HANDLE NOZZLE W / GRIP	791116	1	791116	1	791116	1
79	WASHER FENDER 5/16	*8172020	4	*8172020	4	*8172020	4
80	SCREW CAP 5 /16 - 18 X 1 3/4	*8041031	2	*8041031	2	*8041031	2
81	LABEL DO NOT FILL WHEN ENGINE IS HOT	400268	1	400268	1	400268	1
82							
83	GRIP HANDLE	500267	4	500267	4	500267	4
84	PLUG CAP	890132	4	890132	4	890132	4
85	FRAME SIDE RIGHT WA TR/HTR	811100	1	811100	1	811100	1
86	FRAME SIDE LEFT WA TR/HTR	811101	1	811101	1	811101	1
87	STRAIN RELIEF	500282	1	500282	1	500282	1
88	PLUNGER SWITCH	890440	1	890440	1	890440	1
89	TUBE HANDLE LIFT	811139	2	811139	2	811139	2
90	KNOB 3/8" SOLID HUB	811230	2	811230	2	811230	2