

2 OPTIONAL ACCESSORIES

SHREDDER KIT

P/N 890209. *Shreds leaves, dramatically reducing total volume.*

HOSE KITS

For vacuuming in hard to reach areas.

Heavy Duty Vacuum

Hose Kit P/N 900943.

4"(102mm) x 10' (3.05m)

Homeowners Vacuum

Hose Kit P/N 900942.

4"(102mm) x 10' (3.05m)

NOZZLE WEAR PLATES

P/N 900810. *Extends nozzle life when used along curbs and hard surfaces.*

STANDARD TURF QUICK DEBRIS BAG

P/N 890307. *Standard on TKD models. For use in leaves and grass in non-dusty conditions.*

OPTIONAL DEBRIS BAGS

QUICK DEBRIS BAG

P/N 890305 *for use in dusty conditions.*

DEBRIS BAG COVER

P/N 900801 *Directs dust downward away from operator.*

ZIPPERLESS QUICK BAG

P/N 890309 *For non dusty conditions that are damaging to zippers.*

1

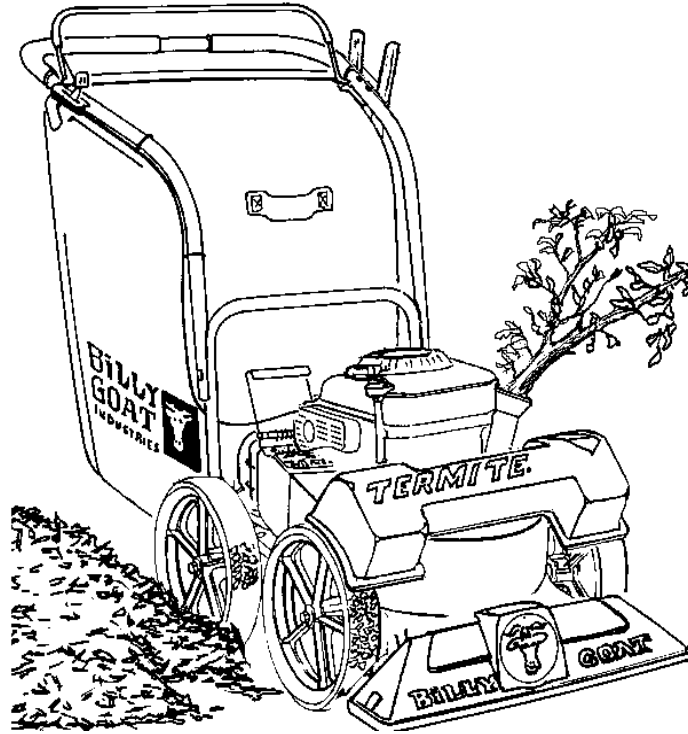

The **TERMITE**®

Thank You for Selecting
The Powerful TKD TERMITE® SELF-PROPELLED VACUUM CHIPPER

Operator Owner's Manual

TKD505SPT

3

Specifications

TKD505SPT

ENGINE: H.P.	5.5 (4.1 kW)
ENGINE: TYPE	TEC. PREMIER
ENGINE: FUEL CAP.	1.5 qt. (1.4 L)
ENGINE: OIL CAP.	0.66 qt. (0.62 L)
WEIGHT: UNIT	126# (57.2 kg)
WEIGHT: SHIPPING	149# (67.6 kg)
ENGINE WEIGHT:	18.75# (8.5 kg)

UNIT SIZE: OVERALL LENGTH: 62"(1.57m) OVERALL WIDTH 26.75"(0.68m) OVERALL HEIGHT 42"(1.07m)

5

IN THE INTEREST OF SAFETY



BEFORE STARTING ENGINE, READ AND UNDERSTAND THE "ENTIRE OPERATOR'S MANUAL & ENGINE MANUAL."



THIS SYMBOL MEANS WARNING OR CAUTION. DEATH, PERSONAL INJURY AND/OR PROPERTY DAMAGE MAY OCCUR UNLESS INSTRUCTIONS ARE FOLLOWED CAREFULLY.



WARNING: The Engine Exhaust from this product contains chemicals known to the State of California to cause cancer, birth defects or other reproductive harm.

WARNING: DO NOT

1. **DO NOT** run engine in an enclosed area. Exhaust gases contain carbon monoxide, an odorless and deadly poison.
2. **DO NOT** place hands or feet near moving or rotating parts.
3. **DO NOT** store, spill or use gasoline near an open flame, or devices such as a stove, furnace, or water heater which use a pilot light or devices which can create a spark.
4. **DO NOT** refuel indoors where area is not well ventilated. Outdoor refueling is recommended.
5. **DO NOT** fill fuel tank while engine is running. Allow engine to cool for 2 minutes before refueling. Store fuel in approved safety containers.
6. **DO NOT** remove fuel tank cap while engine is running.
7. **DO NOT** operate engine when smell of gasoline is present or other explosive conditions exist.
8. **DO NOT** operate engine if gasoline is spilled. Move machine away from the spill and avoid creating any ignition until the gasoline has evaporated.
9. **DO NOT** transport unit with fuel in tank.
10. **DO NOT** smoke when filling fuel tank.
11. **DO NOT** choke carburetor to stop engine. Whenever possible, gradually reduce engine speed before stopping.
12. **DO NOT** run engine at excessive speeds. This may result in injury & /or damage to unit.

13. **DO NOT** tamper with governor springs, governor links or other parts which may change the governed engine speed.

14. **DO NOT** tamper with the engine speed selected by the engine manufacturer.

15. **DO NOT** check for spark with spark plug or spark plug wire removed. Use an approved tester.

16. **DO NOT** crank engine with spark plug removed. If engine is flooded, place throttle in "FAST" position and crank until engine starts.

17. **DO NOT** strike flywheel with a hard object or metal tool as this may cause flywheel to shatter in operation. Use proper tools to service engine.

18. **DO NOT** operate engine without a muffler. Inspect periodically and replace, if necessary. If engine is equipped with muffler deflector, inspect periodically and replace, if necessary, with correct deflector.

19. **DO NOT** operate engine with an accumulation of grass, leaves, dirt or other combustible material in the muffler area.

20. **DO NOT** use this engine on any forest covered, brush covered, or grass covered unimproved land unless a spark arrester is installed on the muffler. The arrester must be maintained in effective working order by the operator. In the State of California the above is required by law (Section 4442 of the California Public Resources Code). Other states may have similar laws. Federal laws apply on federal lands.

21. **DO NOT** touch hot muffler, cylinder, or fins because contact may cause burns.

22. **DO NOT** run engine without air cleaner or air cleaner cover.

23. **DO NOT** operate during excessive vibration!

24. **DO NOT** leave machine unattended while in operation.

25. **DO NOT** park machine on a steep grade or slope.

WARNING: DO



1. **ALWAYS DO** remove the wire from the spark plug when servicing the engine or equipment TO PREVENT ACCIDENTAL STARTING.

2. **DO** keep cylinder fins and governor parts free of grass and other debris which can affect engine speed.

3. **DO** pull starter cord slowly until resistance is felt. Then pull cord rapidly to avoid kickback and prevent hand or arm injury.

4. **DO** examine muffler periodically to be sure it is functioning effectively. A worn or leaking muffler should be repaired or replaced as necessary.

5. **DO** use fresh gasoline. Stale fuel can gum carburetor and cause leakage.

6. **DO** check fuel lines and fittings frequently for cracks or leaks. Replace if necessary

7. **Follow** engine manufacturer operating and maintenance instructions.

8. **Inspect** machine and work area before starting unit.

6 TABLE OF CONTENTS

SAFETY INSTRUCTIONS	2
GENERAL SAFETY	3
ASSEMBLY	3
PARTS BAG & CONTROLS	4
LABELS	4
OPERATION	5 - 7
MAINTENANCE	8 - 9
PARTS DRAWING & LIST	10 - 12
TROUBLESHOOTING	12
WARRANTY PROCEDURE	12

Part No. 890316

7

SOUND

€ L_{WA}
97

SOUND TESTS

Sound tests conducted were in accordance with 79/113/EEC and were performed on 05/19/95 under the conditions listed:

GENERAL CONDI- Sunny
TION:

3 L_{pA}
109

TEMPERATURE: 62°F (16.7°C)

WIND SPEED: 5 MPH (8.0 kmh)

WIND DIRECTION: South

HUMIDITY: 67 %

OPERATOR

BAROMETRIC PRESSURE: 30.06" Hg (763mm Hg)

8

VIBRATION

VIBRATION LEVEL 2.2g

Vibration levels at the operators handles were measured in the vertical, lateral, and longitudinal directions using calibrated vibration test equipment. Tests were performed on 05/19/95 under the conditions listed:

GENERAL CONDI- Sunny
TION:

TEMPERATURE: 62°F (16.7°C)

WIND SPEED: 5 MPH (8.0 kmh)

WIND DIRECTION: South

HUMIDITY: 67 %

BAROMETRIC PRESSURE: 30.06" Hg (763mm Hg)

Page 2 of 12

Form No. F082195D

9 GENERAL SAFETY

For your safety and the safety of others, these directions should be followed:

Do not operate this machine without first reading owner's manual and engine manufacturer's manual.

Use of Ear Protection is recommended while operating this machine.

Use of Eye and Breathing protection is recommended when using this machine, especially in dry and dusty conditions. Optional bag cover directs dust toward ground, away from the operator.

- DO NOT place hands or feet inside nozzle intake opening, near debris outlet or near any moving parts.
- DO NOT start engine without debris bag and quick disconnect connected firmly in place to exhaust outlet.
- DO NOT start or operate machine with debris bag zipper open.

- DO NOT operate during excessive vibration.
- DO NOT remove bag until engine has been turned off and has come to a complete stop.
- DO NOT remove hose kit cap on nozzle until engine has been turned off and has come to a complete stop.
- DO NOT operate machine with hose cap, bag or hose removed.
- DO NOT use this machine for vacuuming **exclusively** sand, dust, fine dirt, rock, glass, string like material, grain, rags, cans, metal, bark or water.
- DO NOT operate this machine on slopes greater than 20%.
- DO NOT pick up any hot or burning debris, or any toxic or explosive material.
- DO NOT allow children to operate this equipment.

10 ASSEMBLY

Read all safety and operating instructions before assembling or starting this unit.

PUT OIL IN ENGINE BEFORE STARTING.

Your Billy Goat is shipped from the factory in one carton, completely assembled except for the upper handle, debris bag, tamper and bag quick disconnect.

1. **ASSEMBLE** Lift upper handle (item 6), remove items 8, 73, 74, & 30 from lower handle (item 27). Attach upper and lower handle as shown, and securely tighten folding handle knobs (item 73), while holding head of screw (item 8) firmly against upper handle.
2. **UNFOLD** the debris bag (item 1) and fasten bag neck to bag quick disconnect (item 83). Attach firmly to housing exhaust (item 52) see fig. 2.
3. **ATTACH** bag hanger strap to bag supports (item 11), preassembled to upper handle.
4. **INSTALL** tamper (item 85) in chipper hopper (see page 7).
5. **CONNECT** spark plug wire.

11 PACKING CHECKLIST

These items should be included in your carton. If any of these parts are missing, contact your dealer.

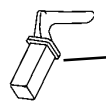
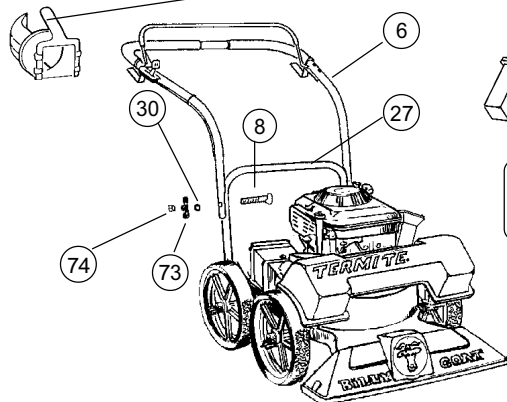
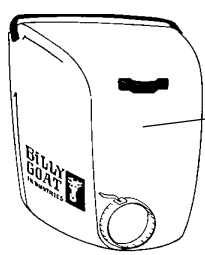

Literature Assy

Engine Manual

Check <input type="checkbox"/>	Debris Bag 890306
Check <input type="checkbox"/>	Connector Quick Disconnect 890176
Check <input type="checkbox"/>	Tamper 890229
Check <input type="checkbox"/>	Literature Assy 890325
Check <input type="checkbox"/>	Tecumseh P/N181-656-1 English

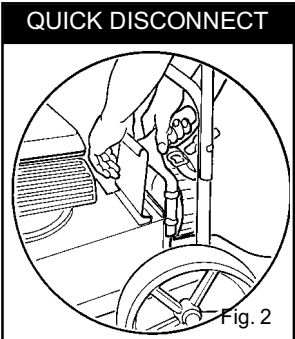

Literature Checklist	
Owner's Manual	<input type="checkbox"/> Check Owner's Manual 890316
Literature KD / TKD Accessories	<input type="checkbox"/> Check Literature KD / TKD Accessories 890317
Warranty Card	<input type="checkbox"/> Check Warranty Card 400972

Throttle Control

Start position

Tecumseh engines have a primer button carburetor with no choke.

Stop position



INSTRUCTION LABELS

These labels should be included on your Vacuum. If any of these labels are damaged, replace them before putting this equipment into operation. Item and part numbers are given to help in ordering replacement labels..



Label Do Not Fill While Engine Is Hot
Item 63 Part No.400268

Label Danger Keep Hands and Feet Away
Item 29 Part No.400424



Label Danger Chipper For Wood Only
Item 48 Part No. 890152



Label Oil Chain
Item No. 45
Part No. 830502



Label Ear Eye Breathing
Item No. 37 Part No. 890254



Label Danger Flying Material
Item 62 Part No.810736



Label Warning Guards
Item 100 Part No.900327



Label Clutch Item No. 99
Part No. 830503

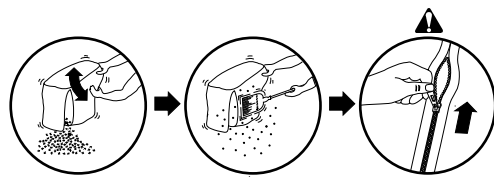

Debris Bag
Label item 1



Label Read Owner's Manual
Item No. 123
Part No. 890301

ENGINE LABELS

Tecumseh



TECUMSEH ENGINE INSTRUCTIONS

CAUTION:
FOR YOUR PERSONAL PROTECTION, READ ALL SAFETY NOTES IN ENGINE OWNER'S MANUAL.

OPERATION:
FOR DETAILED LUBRICATION, STARTING, AND OPERATING INSTRUCTIONS, SEE ENGINE OWNER'S MANUAL & EQUIPMENT MFR'S. INSTRUCTIONS

LUBRICATION:
 SUMMER SAE 30 OIL
 WINTER SAE 5W-30 OIL

TECUMSEH PRODUCTS COMPANY
 900 NORTH STREET GRAFTON, WI 53024, U.S.A.

OPERATION

INTENDED USE: This machine is designed for vacuuming leaves, grass clippings and other types of organic litter and for chipping brush, limbs, corn and sunflower stalks and palm fronds.

Debris mixed with cans, bottles and small amounts of sand can be vacuumed; however, it is not this machine's primary purpose. Vacuuming cans, bottles and sand will affect the longevity of your machine.

Do not operate if excessive vibration occurs. If excessive vibration occurs, shut engine off immediately and check for damaged or worn impeller, loose impeller bolt, loose impeller key, loose engine or lodged foreign objects. Note: See parts list for proper impeller bolt torque specifications. (See trouble shooting section on page 12).



Like all mechanical tools, reasonable care must be used when operating machine.

Inspect machine work area and machine before operating. Make sure that all operators of this equipment are trained in general machine use and safety.



PUT OIL IN ENGINE BEFORE STARTING.

16.1

STARTING



ENGINE: See engine manufacturer's instructions for type and amount of oil and gasoline used. Engine must be level when checking and filling oil and gasoline.

ENGINE SPEED: Controlled by throttle lever on the handle. Under normal conditions, operate at minimum throttle to accomplish your current cleaning task.

FUEL VALVE: Move fuel valve to "ON" position (when provided on engine).

CHOKE: See Primer.

PRIMER: Push primer per engine instructions.

THROTTLE: Move remote throttle control to fast position. Pull starting rope to start engine.

IF YOUR UNIT FAILS TO START:

See Troubleshooting on page 12.

16.2

VACUUMING OPERATION

VACUUM NOZZLE HEIGHT ADJUSTMENT: is raised and lowered by lifting slightly upward on handle and pulling height adjust rod (item 23) at left rear of machine.

FOR MAXIMUM PICKUP: Adjust nozzle close to debris, but without blocking airflow into the nozzle. *NOTE:* Never bury nozzle into debris.

CLEARING A CLOGGED NOZZLE

& EXHAUST: Turn engine off and wait for impeller to stop completely and disconnect spark plug wire. Wearing durable gloves, remove clog. **Danger**, the clog may contain sharp materials. Reconnect spark plug wire.



16.7

CHIPPING OPERATION



Wearing Eye Protection and Durable Gloves is recommended while operating chipper.



Use caution when using chipper

Your **TERMITE**® chipper is designed to process tree branches and limbs up to 2" (50.8mm) diameter.

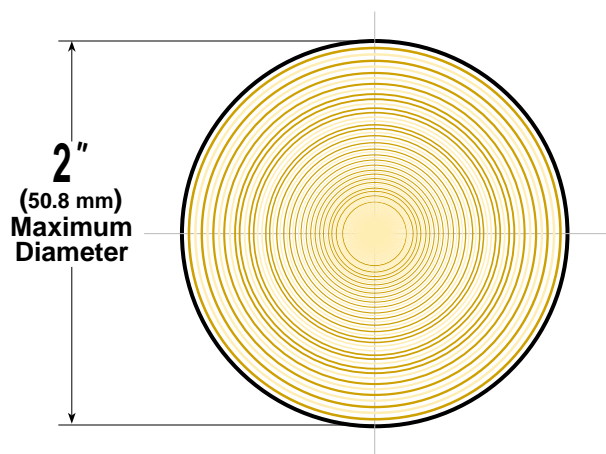

Several small branches can be grouped together and fed together into the chipper (see fig 2.).

When feeding forked branches, squeeze forks together and feed into chipper entrance (DO NOT overload). If forks are too large, use a pair of loppers to trim forks down to size. A lopper storage bracket is provided on every unit (loppers are not included).

16.8

CLEARING A CLOGGED CHIPPER HOPPER



Under normal circumstances, allow time for machine to clear all wood from chipper hopper before stopping engine. Otherwise, remaining pieces of wood will jam inside of chipper when engine stops. See Tamper on page 7.

Disconnect spark plug wire.

Remove debris bag quick disconnect from debris outlet on machine.

Wearing durable gloves, access impeller through debris outlet on fan housing and rotate impeller counter clock wise to dislodge and remove jam and remove debris from hopper with tongs or equivalent.

Reconnect debris bag quick disconnect to machine.

Reconnect spark plug wire.



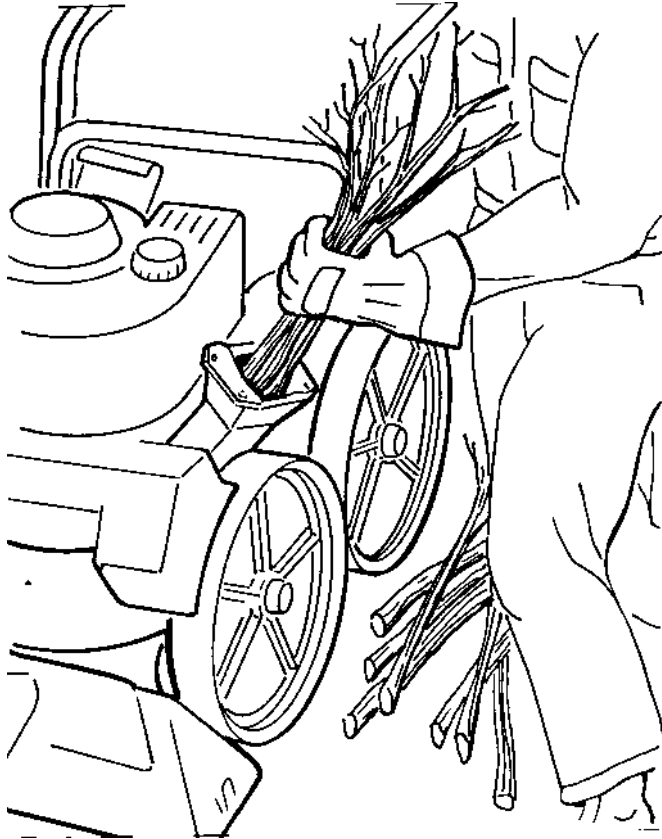

(fig. 2) Note: Dry wood is harder to chip than green wood.

16.9 MULCH

Wood chips made from branches in your own yard make excellent mulch. A thick blanket of wood chips around plants and flowers keeps weeds out and moisture in (see fig. 3).

16.10 COMPOST

Vacuumed leaves, grass and other organic material from your own yard can be emptied into a pile or composter to provide enriched soil for later use as fertilizer in gardens and flower beds (see fig. 3).

Note: Allow green chips to dry before spreading around living plants.

16.3 DEBRIS BAG

Debris bags are normal replaceable wear items.

▲ Note: Frequently empty debris to prevent bag overloading with more weight than you can lift.

An optional bag and dust cover is available for use where debris will be vacuumed in dusty conditions (see **Optional Accessories shown on page 1.**)

DO NOT place bag on or near hot surface, such as engine. Run engine at 1/2 throttle for first 1/2 hour to condition new bag. Your new bag requires a break-in period to condition the pores of the material against premature blockage. The entire bag surface serves as a filter, and must be able to breathe to have good vacuum performance. Be sure engine has come to a complete stop before removing or emptying bag.

This vacuum is designed for picking up trash, organic material and other similar debris (see Safety Warnings page 2-3). However, many vacuums are used where dust is mixed with trash. Your unit can intermittently vacuum in dusty areas. Dust is the greatest cause of lost vacuum performance. However, following these rules will help maintain your machine's ability to vacuum in dusty conditions:

- Run machine at idle to quarter throttle.
- The debris bag must be cleaned more frequently. A vacuum with a clean, pillow soft bag will have good pickup performance. One with a dirty, tight bag will have poor pickup performance. If dirty, empty debris and vigorously shake bag free of dust.
- Machine or pressure-wash debris bag if normal cleaning does not fully clean bag. Bag should be thoroughly dry before use.

Having one or more spare debris bags is a good way to reduce down time while dirty bags are being cleaned.

- DO NOT** leave debris in bag while in storage.



(fig. 3)

16.6

PROPULSION

This vacuum is self-propelled. To engage the drive, pull operator's bail against operator's handle. The drive is disengaged by releasing the operator's bail.

GROUND SPEED can be varied by applying slight downward pressure to handle during operation (to allow drive wheels partial slippage) or by changing the engine rpm.

For improved control in confined areas, this machine can be freewheel pushed forward or backward by releasing the operator's bail and pushing machine.

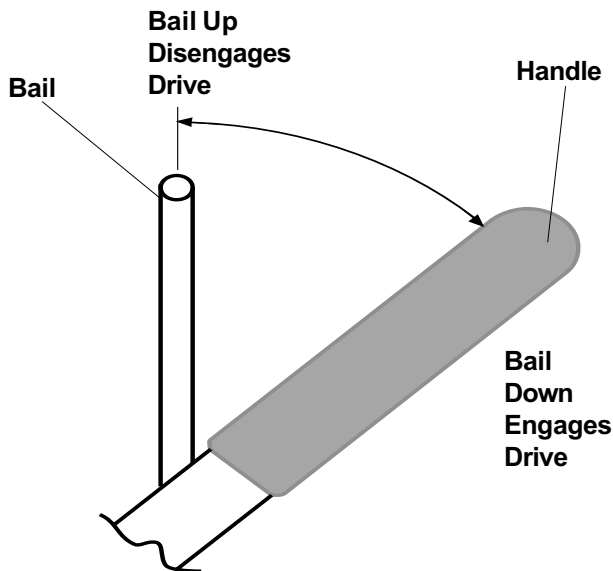

16.12

TAMPER

Before turning machine off, use the Tamper to slowly push remaining pieces of wood through the chipper. This can prevent any remaining wood from jamming in the chipper when machine is turned off.

16.4

HANDLING & TRANSPORTING:

Using two people to lift machine is recommended. Lift holding the handle and front of nozzle. Secure in place during transport.

16.5

STORAGE

⚠ Never store engine indoors or in enclosed poorly ventilated areas with fuel in tank, where fuel fumes may reach an open flame, spark or pilot light, as on a furnace, water heater, clothes dryer or other gas appliance.

If engine is to be unused for 30 days or more, prepare as follows:

⚠ Be sure engine is cool. Do not smoke. Remove all gasoline from carburetor and fuel tank to prevent gum deposits from forming on these parts and causing possible malfunction of engine. Drain fuel outdoors, into an approved container, away from open flame. Run engine until fuel tank is empty and engine runs out of gasoline.

NOTE: Fuel stabilizer (such as Sta-Bil) is an acceptable alternative in minimizing the formation of fuel gum deposits during storage. Add stabilizer to gasoline in fuel tank or storage container. Always follow mix ratio found on stabilizer container. Run engine at least 10 min. after adding stabilizer to allow it to reach the carburetor.

⚠ Do not store with debris in bag.

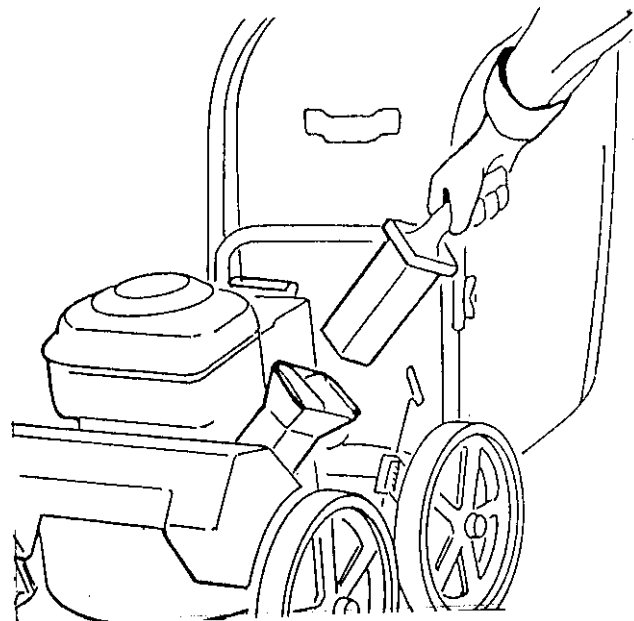

Tamper Storage Position.



Use only a qualified mechanic for any adjustments, disassembly or any kind of repair .



WARNING: TO AVOID PERSONAL INJURY, ALWAYS TURN MACHINE OFF, MAKE SURE ALL MOVING PARTS COME TO A COMPLETE STOP.



DISCONNECT SPARK PLUG WIRE BEFORE SERVICING UNIT.



ENGINE: See engine manufacturer operator's instructions.

DEBRIS BAG: See page 6.



RECONNECT SPARK PLUG WIRE, GUARDS, BAG, CAPS AND / OR HOSE BEFORE STARTING ENGINE.

IMPELLER REMOVAL and CHIPPER ADJUSTMENT

IMPELLER REMOVAL

1. Wait for engine to cool and disconnect spark plug.
2. Drain fuel and oil from the engine.
3. Remove bag, quick release, upper handle and clutch cable from upper handle. Do not kink, stretch, or break control cables, control housings, or end fittings while removing handles.
4. Remove chain guard, chains and jackshaft assembly (see page 9, Drive Chain).
5. Remove housing top plate by removing bolts around outside of housing.
6. Leaving engine fastened to top plate, remove impeller bolt and lock washer and slide impeller off crankshaft (A puller may be required).
7. Retain shim washers used at end of crankshaft for use at impeller reinstallation (see fig. 7). However, your unit may or may not have required the use of shim washers.
8. If impeller slides off freely, proceed to (step 11 or step 15). **(Do not drop impeller).**
9. If impeller does not slide off crankshaft, place two crowbars between impeller and housing on opposite sides. Pry impeller away from engine until it loosens. *Using a penetrating oil can help loosen a stuck impeller.*
10. If the impeller cannot be loosened, obtain a 1" (25.4mm) longer bolt of the same diameter and thread type as the impeller bolt. Invert engine and impeller and support engine above ground to prevent recoil damage. Thread longer bolt by hand into the crankshaft until bolt bottoms. Using a suitable gear or wheel puller against the bolt head and the impeller back-plate (near the blades), remove impeller from shaft.

CHIPPER BLADE REMOVAL AND SHARPENING

Chipper blades are normal replaceable wear items.



DANGER Chipper blade is sharp. Replace any damaged blade.

Depending on the type and amount of wood being chipped, the chipper blade will eventually get dull, losing its cutting ability. Evidence of a dull blade is a noticeably reduced chipping ability or a rough cut on end of branch.

Note: The chipper blade gap is factory set and should be checked each time impeller is removed from engine crankshaft and reset if required. If reassembly requires a different quantity of shim washers, Billy Goat® shim washer must be used.

11. Using a 3/16" Allen wrench and 1/2" open end wrench, remove chipper blade from impeller.
12. Sharpen blade by lightly grinding the cutting edge of the blade at **40 degrees** (see fig. 5). It is not necessary to remove all nicks from the cutting edge. **CAUTION:** Be careful to avoid heat buildup in the blade during sharpening. This will reduce its heat-treated hardness properties and will reduce blade life. Evidence of too much heat build-up is a change of color along sharpened edge.
13. The same chipper blade can be sharpened several times. However, blade replacement is required when blade no longer overhangs the chip relief hole in impeller back plate or if increased vibration occurs (see fig. 5).
14. Chipper blade installation is in reverse order of removal.

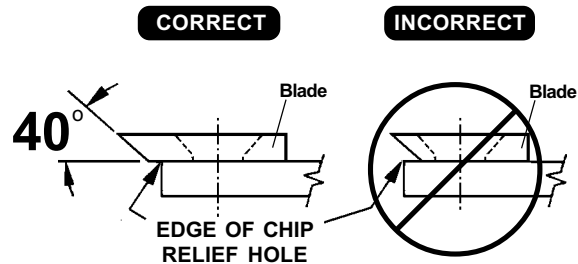

Fig. 5

15. To reinstall impeller, use a new impeller bolt and lockwasher and use exactly the same crankshaft impeller shim washers as were removed during disassembly (unless they were damaged). *However, your unit may or may not have required the use of shim washers.*
16. Tighten impeller bolt. Torque impeller bolt to 50 Ft. Lbs. (68 N-m) (see item 51 on page 11).
17. Slowly rotate impeller to insure proper chipper blade clearance. Check to see that gap between chipper blade and anvil surface (on lower side of housing top plate) measures between 0.040" (1.02mm) and 0.080" (2.03mm).
18. If gap is less than 0.040" (0.51mm), add shim washer 890130 (0.060" {1.52mm} thick) and/or 890131 (0.020" {1.02mm} thick), whichever is required. If gap is more than 0.080" (2.03mm), remove one or more shim washers as needed to obtain correct gap (see fig. 6 & fig. 7). The chipper will function at up to a maximum of 0.125" (3.18mm) gap.

17.1 IMPELLER REMOVAL and CHIPPER

19. If chipper blade properly clears anvil surface, proceed to step 20. If not, return to (step 14) and add or subtract shim washers as needed to obtain a correct gap.
20. Reinstall engine, impeller and jackshaft assembly components onto housing in reverse order of removal (see drive section on page 9).
21. Before connecting spark plug wire, slowly pull engine starting rope to insure that impeller rotates freely.
22. Reinstall spark plug wire.



fig. 6

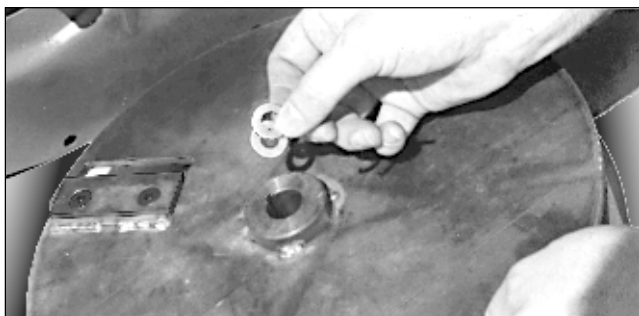

fig. 7

17.3 DRIVE

Chains are normal replaceable wear items. A new chain should not be used on worn sprockets. Sprockets should be replaced when replacing chains.



Stop engine and disconnect spark plug wire before making adjustments.

CHAIN ADJUSTMENTS

1. Remove chainguard (item 118) and 3 screws (item 81 & 71).
2. Inspect chains (items 87 & 88), for wear, (see chain replacement), lubrication and correct adjustment.
3. If adjustments are required, loosen 4 carriage bolts (item 90), that hold bearing brackets for jackshaft assembly.
4. Adjusting all (3) chains at same time is necessary and can be done by pulling jackshaft (item 93), up and forward.
5. Tension chains - similar to bicycle chain tightness with about 1/8" (3.2mm) deflection with light hand pressure mid-way between sprockets. A slightly loose chain is better than an over tightened chain. DO NOT over tighten.
6. With chains aligned and tensioned, and jackshaft (item 93), square and level, tighten carriage bolts (item 90).
7. Completely rotate drive wheels around several times to insure there are no excessively tight areas in the chain.
8. Repeat steps 4 thru 7 if chains need readjustment.
9. Reinstall chainguard (item 118).

CHAIN REPLACEMENT

1. With chain guard removed, loosen carriage bolts (item 90), that hold jackshaft (item 93), and bearing plates (item 101).
2. To replace inner chain (item 88), remove jackshaft assembly and install replacement chain.
3. To replace wheel chains (item 87), slide bearing plates (item 101), toward engine to loosen chains. Remove front wheels. Reinstall replacement chains with wheels and onto jackshaft sprockets.
4. See steps 4 thru 7 for chain alignment and adjustment.
5. Reinstall chainguard (item 118).

CLUTCH ADJUSTMENT

The clutch control cable is pre-adjusted at the factory, so when the bail is released, rod (item 115), engages clutch assembly (item 121), to stop forward drive motion and allow forward and backward free-wheeling. When the bail is held against handle, the clutch rod moves away from clutch assembly to allow drive engagement.

If drive will not disengage, adjust and align control bracket so that rod (item 115) fully contacts triangular plate on clutch assembly when bail is released (see fig. 8).

See lubrication intervals on Maintenance Schedule.

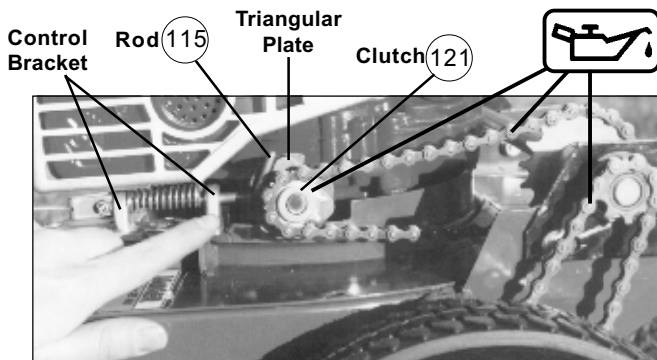
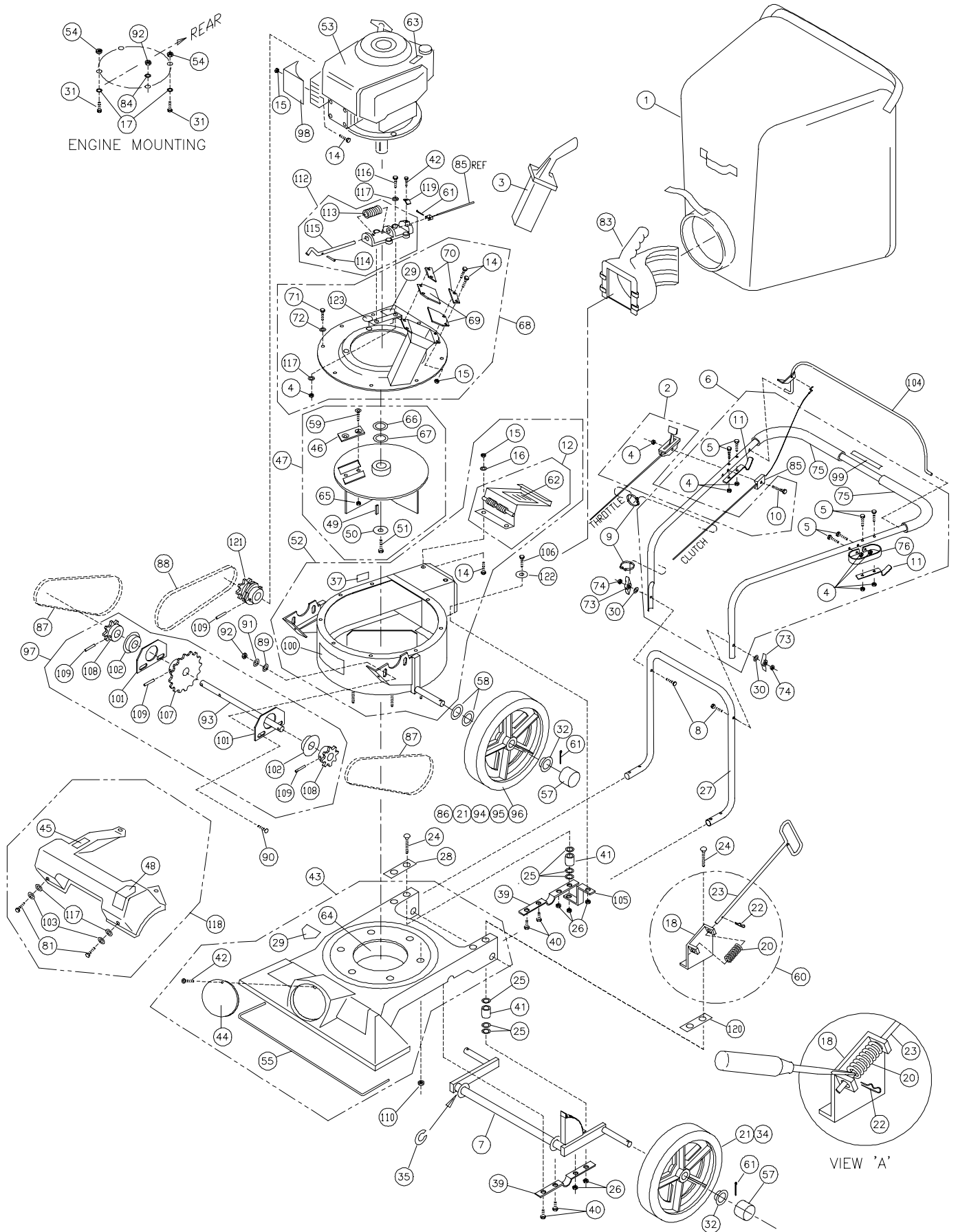
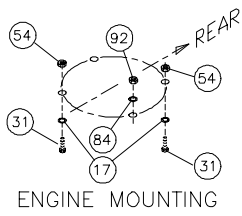

Fig. 8

17.2 Maintenance Schedule

Follow these hourly maintenance intervals.

Maintenance Operation	Every Use	Every 5 hrs or (Daily)	Every 10 hrs	Every 25 hrs
Engine (See Engine Manual)				
Check for excessive vibration		●		
Clean Debris Bag	●			
Check bag strap tightness	●			
Inspect for loose parts		●		
Inspect for worn or damaged parts		●		
Lubricate Chains and Clutch			●	
Inspect Chains and Clutch				●



18 PARTS DRAWING
TKD505SPT

Item No.	19 PARTS LIST	Description	TKD505SPT	Qty.
			Part No.	
1		DEBRIS BAG TURF (service)	890307	1
2		THROTTLE ASSEMBLY (INCL. 1 ea items 4, 10)	900514-04	1
3		TAMPER	890229	1
4		NUT LOCK (1/4 - 20)	*8160001	7
5		SCREW CAP (1/4 - 20 x 1-1/2 HEX)	*8041008	6
6		HANDLE ASS'Y (incl. items 4(6), 5(4), 11(2), 75(2) & 76, 99)	900057	1
7		AXLE REAR - FRAME W.A.	900956	1
8		SCREW HANDLE 5/16 - 18 x 2-1/4	900547	2
9		CLAMP CABLE PLASTIC 1"	900813	2
10		SCREW CAP 1/4 - 20 x 2 1/4	*8041011	1
11		BAR SUPPORT BAG	900039	2
12		DOOR EXHAUST ASS'Y (incl. item 62)	890148	1
13				
14		SCREW CAP #10 - 24 x 5/8	*8059135	7
15		NUT LOCK #10 NC	*8164005	7
16		WASHER #10 FC	*8171001	2
17		WASHER LOCK 3/8 INT.	*8180011	2
18		BRACKET - HEIGHT ADJUSTMENT	900932	1
19				
20		SPRING	900136	1
21		TIRE - ONLY (PER ASSY) TREADED	900659	1
22		PIN - HAIR COTTER	900471	1
23		ROD SHORT HEIGHT ADJUSTMENT	890110	1
24		BOLT - CARRIAGE 5/16 - 18 x 3-1/2	*8024050	4
25		WASHER - FLAT 5/16 SAE	*8172008	12
26		NUT LOCK 5/16 - 18 HEX	*8160002	5
27		HANDLE LOWER KD505	900041	1
28		PLATE HANDLE SUPPORT	900933	1
29		LABEL DANGER CUT FINGER	400424	2
30		WASHER FLAT CUT 5/16	*8171003	2
31		SCREW CAP 3/8 - 16 X 2 1/2 WASHER FACE	900564	2
32		WASHER HUB CAP 1/2 I.D.	900927	4
33				
34		WHEEL ASS'Y CAST (incl. items 21) TREADED	900760	2
35		WASHER 0.75 "C"	900997	1-0
36				
37		LABEL EAR EYE BREATHING	890254	1
38				
39		PLATE BRACE REAR	890189	2
40		SCREW CAP 1/4 - 20 x 1/2	*8041002	4
41		SPACER	900926	4
42		SCREW SELF TAPPING 10 - 24 x 1/2	*8123086	2
43		NOZZLE MAINFRAME ASS'Y (incl. one of items 29, 44, 42, 55, 64)	900966	1
44		PLUG	900146	1
45		LABEL OIL CHAIN	830502	1
46		BLADE CHIPPER	890101	1
47		IMPELLER ASS'Y (incl. items 46, 49, 50, 51, 59, 65, 66, 67)	890208-S	1
48		LABEL CHIPPER	890152	1
49		KEY 3/16 SQ. x 1.25	9201080	1
50		WASHER LOCK 3/8 TWISTED TOOTH	400502	1
51		SCREW CAP 3/8 - 24 x 2" (HARDENED) (TORQUE 50 FT-LBS) (68 N·m)	810962	1
52		HOUSING ASS'Y (incl. items 12, 14, 15, 16, 37, 100)	890202	1
53		ENGINE 5.5 H.P. TECUMSEH PREMIER	890228	1
54		NUT LOCK 3/8 16	*8160003	2
55		ROD BUMPER	900939	1
56				
57		CAP HUB	900486	4
58		WASHER FLAT 1/2 SAE	*8172011	4
59		SCREW SOCKET HD. 5/16 - 18 x 3/4 GR. 8	890103	2
60		HT ADJUST ASSY	890326	1
61		PIN COTTER 3/32 x 3/4	*8197016	5
62		LABEL DANGER FLYING MATERIAL	810736	1
63		LABEL HOT ENGINE	400268	1
64		GUARD FOAM INSERT	900977	1
65		NUT KEPS 5/16 -18	890104	2
66		WASHER SHIM 0.060" (1.52mm)	890130	0-1
67		WASHER SHIM 0.020" (0.51mm)	890131	0-2
68		PLATE TOP ASS'Y (incl. items 14, 15, 29, 69, 70, 71, 72)	890188	1
69		GUARD FLAPPER	890119	2
70		PLATE FLAPPER ENTRANCE	890127	2
71		SCREW CAP 5/16 - 18 x 1/2 HEX HD. GR. 5	890149	9
72		WASHER LOCK CONICAL 5/16	890150	9
73		KNOB WING 5/16 - 18	890108	2
74		NUT LOCK 5/16 - 18 THIN HT.	*8161041	2
75		GRIP HANDLE	400570	2
76		BRACKET LOPPER LOOP	890167	1
77			900640	1
78				
79				
80				
81		SCREW CAP 1/4 - 20 x 3/4	*8041004	2
82				
83		CONNECTOR QUICK	890176	1
84		WASHER 5/16 EXT.	*8181008	1
85		CABLE ASS'Y CLUTCH	900207	1

* Denotes standard hardware item that may be purchased locally.

19

Parts List
continued from
page 11.

Item No.	Description	TKD505SPT Part No.	Qty.
86	WHEEL WITH SPROCKET ASS'Y CAST (21, 94, 95, 96)	890242	2
87	CHAIN 52 PITCH	890239	2
88	CHAIN 40 PITCH	900323	1
89	WASHER FLAT 5/16 (3/8 ID x 7/8 x 1/16)	*8171003	4
90	BOLT CARRIAGE 5/16 -18 x 3/4	*8024039	4
91	WASHER SPRING LOCK 5/16	*8177011	4
92	NUT REGULAR 5/16-18	*8142002	5
93	JACKSHAFT	900320	1
94	SPROCKET (PER ASSEMBLY) (SIZE # 65A26) 26 TEETH	890238	1
95	SCREW SELF TAP 1/4-14 x 3/4 (PER ASSEMBLY)	800505	5
96	WASHER LOCK EXTERNAL TOOTH (PER ASSEMBLY)	*8181007	5
97	JACKSHAFT ASS'Y (INCLUDE. 93, 101, 102, 107, 108, 109)	890197	1
98	SHIELD MUFFLER TKDSP	890190	1
99	LABEL CLUTCH	830503	1
100	LABEL-WARNING GUARDS	900327	1
101	BEARING PLATE	900317	2
102	BEARING BALL (WITH SNAP RING)	900321	2
103	WASHER LOCK 1/4	*8177010	2
104	ROD BAIL CLUTCH	900970	1
105	BAR BRACE HANDLE	900768	1
106	SCREW CAP 5/16-18 x 3/4	*8041026	1
107	SPROCKET - 17 TOOTH	900303	1
108	SPROCKET - 8 TOOTH	900302	2
109	ROLL PIN 3/16 DIA. x 1 1/4 LG.	*8195166	4
110	LOCKNUT 5/16 - 18 FLANGE	850164	5
111			
112	BRACKET CONTROL ASS'Y (INCL. 113, 114, 115)	900221	1
113	SPRING	900136	1
114	ROLL PIN 1/8" DIA. x 1 1/4 LG.	*9195106	1
115	ROD CLUTCH	900208	1
116	SCREW CAP 1/4-20 x 1" LG.	*8041006	2
117	WASHER 1/4" FLAT (5/16 ID x 3/4 OD x 1/16)	*8171002	6
118	GUARD CHAIN ASS'Y TKDSP	890195	1
119	CLIP-CLUTCH CABLE	900999	1
120	PLATE BRACE HT. ADJ. KD / TKD	900756	1
121	CLUTCH DOUBLE RELEASE	900307	1
122	WASHER FENDER 5/16	*8172020	1
123	LABEL READ OWNER'S MANUAL	890301	1

* Denotes standard hardware item that may be purchased locally.

20

TROUBLESHOOTING

Before Requesting Service Review These Suggestions

Problem	Possible Cause	Solution
Will not vacuum or has poor vacuum performance.	Dirty debris bag. Nozzle height set too high or too low. Hose kit cap missing. Clogged nozzle or exhaust. Excessive quantity of debris.	Clean debris bag. Shake bag clean or wash. Adjust nozzle height. Check for hose kit cap. Unclog nozzle or exhaust (see page 5). Allow air to feed with debris.
Poor chipping performance.	Extremely hard wood. Dull or damaged chipper blade.	Avoid extremely hard wood. Sharpen or replace chipper blade (see page 8).
Engine stalls or labors when chipping.	Feeding branches into chipper too rapidly. Engine service may be required.	Feed branches at a slower rate. Service engine.
Abnormal vibration.	Loose or out of balance impeller or loose engine.	Check impeller and replace if required. Check Engine.
Engine will not start.	Throttle in off position. Out of gasoline. Bad or old gasoline. Spark Plug wire disconnected. Dirty air cleaner.	Check stop switches, throttle, and gasoline. Connect spark plug wire. Clean or replace air cleaner. Or contact a qualified service person.
No self propelling.	Operator's bail not releasing clutch. Broken or out of adjustment clutch cable. Worn or broken clutch assembly. Bracket control assembly (item 112) out of adjustment.	Adjust clutch cable. Adjust bracket control assembly. Replace any worn or damaged or malfunctioning parts.
Self propelled drive will not release.	Clutch cable out of adjustment. Clutch not lubricated and is locked-up.	Adjust clutch cable. See page 9 Clutch Adjustment. Oil clutch.
Engine is locked, will not pull over.	Debris locked in chipper blade, hopper or inside impeller. Engine problem.	See page 5, Clearing a clogged chipper hopper. Contact an engine servicing dealer for engine problems.

22.1

Engine Service and Warranty
Contact your nearest engine manufacturer's authorized servicing dealer.

21

Serial Plate Record your machine model, serial number and date-of-purchase and where purchased



97



BILLY GOAT INDUSTRIES INC.
1803 S. Jefferson P.O. Box 308
Lee's Summit, MO 64063 / USA
(816) 524-9666 FAX (816) 524-6983

Model

Serial No.

Unit (weight)

lbs kg

Engine Power

kW @ min⁻¹

Operator _____

Purchase Date _____ Purchased from _____

22

WARRANTY PROCEDURE

Please fill in the WARRANTY CARD and send the upper part to Billy Goat. The WARRANTY terms are stated on the lower part which remains with the user. Whenever a Billy Goat Machine is faulty due to a defect in material and / or workmanship, the owner should make a warranty claim as follows:

The Machine should be taken to the dealer from whom it was purchased or to an authorized Billy Goat dealer.

The owner should present the remaining half of the Warranty Registration Card, or, if this is not available, the invoice or receipt.

The Warranty Claim will be filled in by the authorized Billy Goat Dealer, who will send it with the faulty part to Billy Goat headquarters.

The Quality / Service department at Billy Goat headquarters will study the claim and parts and will notify their conclusions.

The decision by the Quality / Service department at Billy Goat headquarters to approve or reject a Warranty claim is final and binding.

Note: To process a Warranty Claim, it is necessary to quote the Model & Serial number who are printed on the Billy Goat Serial Plate.



BILLY GOAT INDUSTRIES INC.
P.O. BOX 308 (1803 S JEFFERSON) LEE'S SUMMIT, MO 64063 / USA
PHONE: 816-524-9666 FAX: 816-524-6983