

1

Operator Owner's Manual

Thank You for Selecting

SV50HR

Quiet Vac®

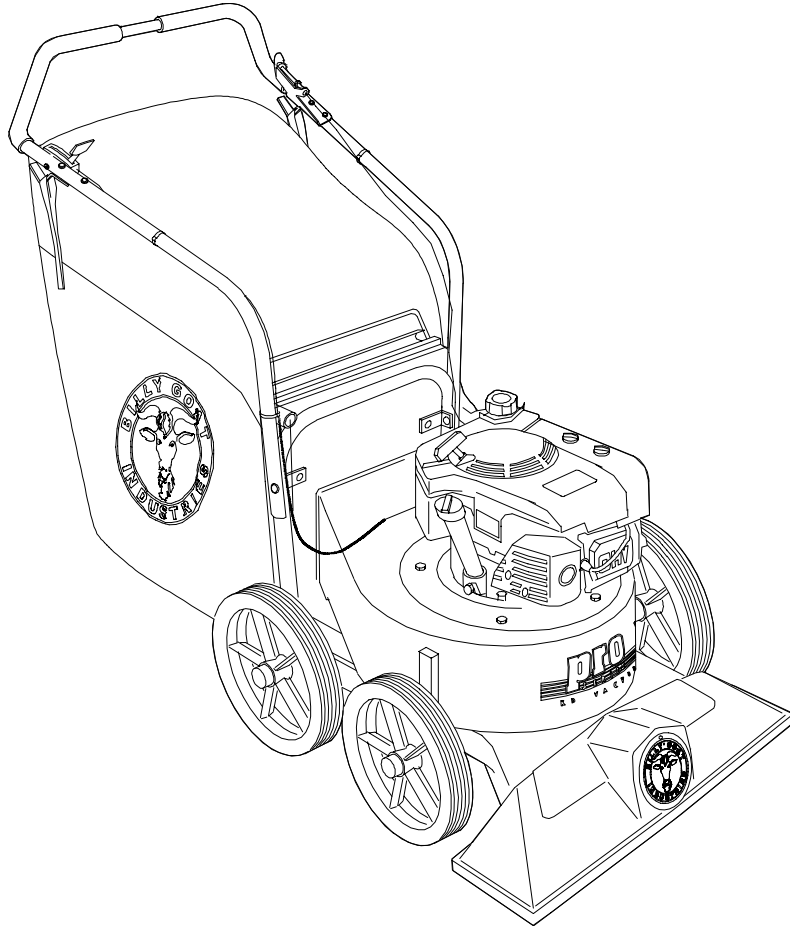

3

SPECIFICATIONS

	SV50HR
ENGINE: H.P.	5.5 (4.1kW)
ENGINE: TYPE	HONDA OHV
ENGINE: FUEL CAP.	1.2qt. (1.1L)
ENGINE: OIL CAP.	0.63qt. (0.60L)
WEIGHT: UNIT	151# (68.5kg)
WEIGHT: SHIPPING	174# (78.9kg)
ENGINE WEIGHT:	36# (16.3kg)
UNIT LENGTH	62" (1.57m)
UNIT WIDTH	26.75" (0.68m)
UNIT HEIGHT	42" (1.07m)

2 ACCESSORIES

HOSE KITS

For vacuuming in hard to reach areas.

Heavy Duty Vacuum Hose Kit P/N 900998.

4"(102mm) X 7' (3.05m)

Hose Extension Kit P/N 890045.

(Kit contains a connector and a clamp, Hose is not included)

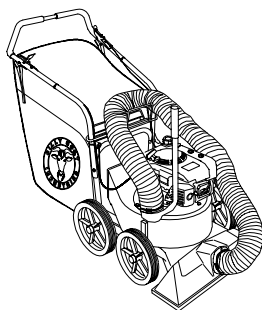

NOZZLE WEAR GUARD (STANDARD)

P/N 890413. Extends nozzle life when used along curbs and hard surfaces.

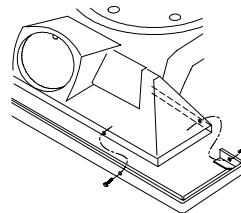

CASTER KIT

P/N 890447 For use on hard surface.

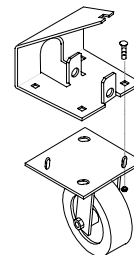

BAG LINER OPTIONS

Felt Filter P/N 890435

For use in all dusty conditions. Can be used with other liners

PACKAGED SINGLY

Litter Liner P/N 890006

For use on hard surface where a variety of debris is present.

QTY 5 PER PACKAGE

Lawn Liner P/N 890009

Used to collect leaves, thatch & grass.

QTY 5 PER PACKAGE

5

IN THE INTEREST OF SAFETY



BEFORE STARTING ENGINE, READ AND UNDERSTAND THE "ENTIRE OPERATOR'S MANUAL & ENGINE MANUAL."



THIS SYMBOL MEANS WARNING OR CAUTION. DEATH, PERSONAL INJURY AND/OR PROPERTY DAMAGE MAY OCCUR UNLESS INSTRUCTIONS ARE FOLLOWED CAREFULLY.



WARNING: The Engine Exhaust from this product contains chemicals known to the State of California to cause cancer, birth defects or other reproductive harm.

WARNING: DO NOT

1. **DO NOT** run engine in an enclosed area. Exhaust gases contain carbon monoxide, an odorless and deadly poison.
2. **DO NOT** place hands or feet near moving or rotating parts.
3. **DO NOT** store, spill or use gasoline near an open flame, or devices such as a stove, furnace, or water heater which use a pilot light or devices which can create a spark.
4. **DO NOT** refuel indoors where area is not well ventilated. Outdoor refueling is recommended.
5. **DO NOT** fill fuel tank while engine is running. Allow engine to cool for 2 minutes before refueling. Store fuel in approved safety containers.
6. **DO NOT** remove fuel tank cap while engine is running.
7. **DO NOT** operate engine when smell of gasoline is present or other explosive conditions exist.
8. **DO NOT** operate engine if gasoline is spilled. Move machine away from the spill and avoid creating any ignition until the gasoline has evaporated.
9. **DO NOT** transport unit with fuel in tank.
10. **DO NOT** smoke when filling fuel tank.
11. **DO NOT** choke carburetor to stop engine. Whenever possible, gradually reduce engine speed before stopping.
12. **DO NOT** run engine at excessive speeds. This may result in injury &/or damage to unit.

13. **DO NOT** tamper with governor springs, governor links or other parts which may change the governed engine speed.
14. **DO NOT** tamper with the engine speed selected by the engine manufacturer.
15. **DO NOT** check for spark with spark plug or spark plug wire removed. Use an approved tester.
16. **DO NOT** crank engine with spark plug removed. If engine is flooded, place throttle in "FAST" position and crank until engine starts.
17. **DO NOT** strike flywheel with a hard object or metal tool as this may cause flywheel to shatter in operation. Use proper tools to service engine.
18. **DO NOT** operate engine without a muffler. Inspect periodically and replace, if necessary. If engine is equipped with muffler deflector, inspect periodically and replace, if necessary, with correct deflector.
19. **DO NOT** operate engine with an accumulation of grass, leaves, dirt or other combustible material in the muffler area.
20. **DO NOT** use this engine on any forest covered, brush covered, or grass covered unimproved land unless a spark arrester is installed on the muffler. The arrester must be maintained in effective working order by the operator. In the State of California the above is required by law (Section 4442 of the California Public Resources Code). Other states may have similar laws. Federal laws apply on federal lands.

21. **DO NOT** touch hot muffler, cylinder, or fins because contact may cause burns.
22. **DO NOT** run engine without air cleaner or air cleaner cover.
23. **DO NOT** operate during excessive vibration!
24. **DO NOT** leave machine unattended while in operation.
25. **DO NOT** park machine on a steep grade or slope.

WARNING: DO

1. **ALWAYS DO** remove the wire from the spark plug when servicing the engine or equipment TO PREVENT ACCIDENTAL STARTING.
2. **DO** keep cylinder fins and governor parts free of grass and other debris which can affect engine speed.
3. **DO** pull starter cord slowly until resistance is felt. Then pull cord rapidly to avoid kickback and prevent hand or arm injury.
4. **DO** examine muffler periodically to be sure it is functioning effectively. A worn or leaking muffler should be repaired or replaced as necessary.
5. **DO** use fresh gasoline. Stale fuel can gum carburetor and cause leakage.
6. **DO** check fuel lines and fittings frequently for cracks or leaks. Replace if necessary
7. **Follow** engine manufacturer operating and maintenance instructions.
8. **Inspect** machine and work area before starting unit.

6

SAFETY INSTRUCTIONS	2
GENERAL SAFETY	3
PARTS BAG	3
CONTROLS & LABELS	3
ASSEMBLY	4
OPERATION	5
PARTS DRAWING & LIST	6-7
MAINTENANCE	8
TROUBLESHOOTING	8
WARRANTY PROCEDURE	8

7

SOUND

Sound tests conducted were in accordance with 2000/14/EEC and were performed on 2/13/2002 under the conditions listed:
NOTE: Sound power level listed is the highest value for any model in this manual. Please refer to serial plate on the unit for the sound power level for your model.



109 dB
(SV50H MODEL)

Sound level of 97 dBA at operator position

GENERAL CONDITION:	Sunny
TEMPERATURE:	48° F (8.9° C)
WIND SPEED:	2 MPH (3.2 kmh)
WIND DIRECTION:	South East
HUMIDITY:	29 %
BAROMETRIC PRESSURE:	30.34" Hg (770mm Hg)

8

VIBRATION

VIBRATION LEVELS 2.5g
Vibration levels at the operators handles were measured in the vertical, lateral, and longitudinal directions using calibrated vibration test equipment. Tests were performed on 04/02/98 under the conditions listed:

GENERAL CONDITION:	Sunny
TEMPERATURE:	67° F (19.4° C)
WIND SPEED:	5 MPH (8.0 kmh)
WIND DIRECTION:	East
HUMIDITY:	41 %
BAROMETRIC PRESSURE:	29.1" Hg (739mm Hg)

For your safety and the safety of others, these directions should be followed:



Do not operate this machine without first reading owner's manual and engine manufacturer's manual.



Use of Ear Protection is recommended while operating this machine.



Use of Eye and Breathing protection is recommended when using this machine, especially in dry and dusty conditions. Debris bag directs dust toward ground, away from the operator and the optional Felt Filter reduces the amount of dust reintroduced into the environment.

- DO NOT place hands or feet inside nozzle intake opening, near debris outlet or near any moving parts.
- DO NOT start engine without debris bag connected firmly in place to exhaust outlet.
- DO NOT start or operate machine with debris bag zipper open.

- DO NOT operate during excessive vibration.
- DO NOT remove bag until engine has been turned off and has come to a complete stop.
- DO NOT remove hose kit cap on nozzle until engine has been turned off and has come to a complete stop.
- DO NOT operate machine with hose cap, bag or hose removed.
- DO NOT use this machine for vacuuming **exclusively** sand, dust, fine dirt, rock, glass, string like material, grain, rags, cans, metal, bark or water.
- DO NOT operate this machine on slopes greater than 20%.
- DO NOT pick up any hot or burning debris, or any toxic or explosive material.
- DO NOT allow children to operate this equipment.

11

PACKING CHECKLIST

These items should be included in your carton. If any of these parts are missing, contact your dealer.



Debris Bag
890351



Literature Assy
890381



Honda Engine
Manual

12

LITERATURE ASSY P/N 890048



Owner's
Manual
890049



Literature
Accesso-
ries 890380



Litter Liner
Installation
instructions
890007



Lawn Liner
Installation
Instructions
890432



Warranty
Card 400972



EU Declaration
of Conformity &
EU Distributor
List 890378

13 CONTROLS

Throttle Control

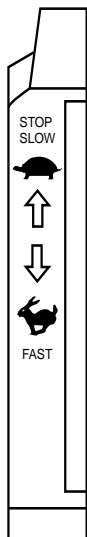

Honda - Place in fast position to start.

14 INSTRUCTION LABELS

These labels should be included on your Vacuum. If any of these labels are damaged, replace them before putting this equipment into operation. Item and part numbers are given to help in ordering replacement labels..



Label Do Not Fill While Engine Is Hot
Item 63 Part No.400268



Label Danger Keep Hands and Feet Away
Item 29 Part No.400424



Label Danger Flying Material
Item 62 Part No.810736



Label Read Owner's Manual Item 84
Part No.890301



Label Ear Eye Breathing
Item No. 86 Part No.
890254

15 ENGINE LABELS

Honda

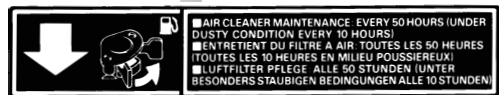

When servicing engine refer to specific manufacturers engine owner's manual. All engine warranty is covered by the specific engine manufacturer. If your engine requires warranty or other repair work contact your local servicing engine dealer. When contacting a dealer for service it is a good idea to have your engine model number available for reference(See table above). If you can not locate a servicing dealer in your area you can contact the manufacturers national service organization.

To reach:

American Honda: Phone: 770-497-6000 Fax: 770-497-6011

ASSEMBLY

Your Billy Goat is shipped from the factory in one carton, completely assembled except for the upper handle and accessories. Included with machine are caster kit (890447), felt filter bag (1 each), lawn liner (3 each), and litter liner (3 each).



Read all safety and operating instructions before assembling or starting this unit.

1.

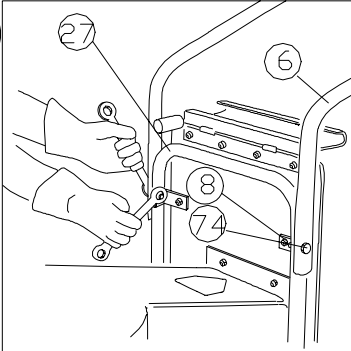

1. **REMOVE** items 8 locknut & 74 screws from lower handle (item 27). Attach and securely tighten upper handle item 6 to lower handle as shown.

5.

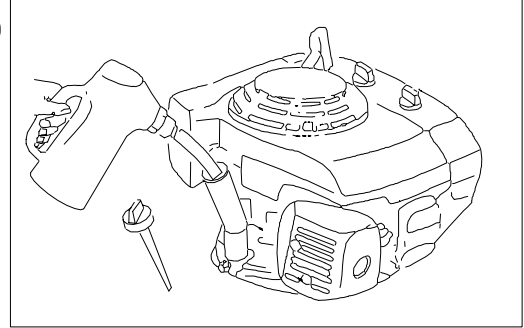

2.

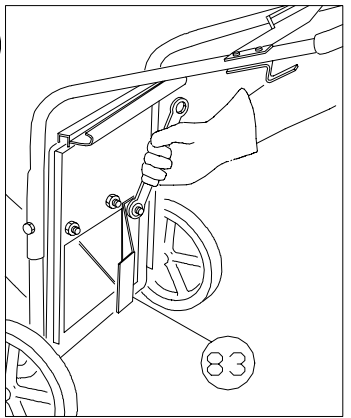

2. **REMOVE** deflector (item 83) from box. Discard packing material. Remove carriage bolts (item 31) and nut (item 4) from deflector. Install to bag plate (item 13) as shown reusing parts removed (nut should be on side shown).



Failure to attach deflector may result in premature wear to bag.

3.

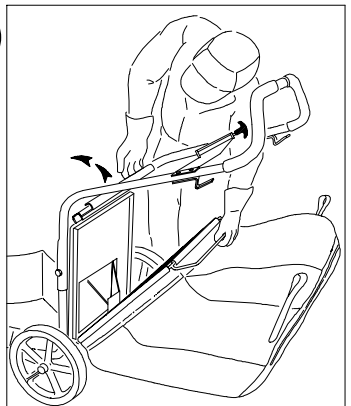

3. **UNFOLD** the debris bag (item 1) position bottom of bag rod below the bag plate and pull up and rotate the top of the bag rod up and secure with the latch.

4.

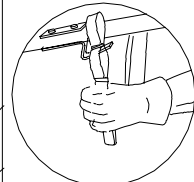
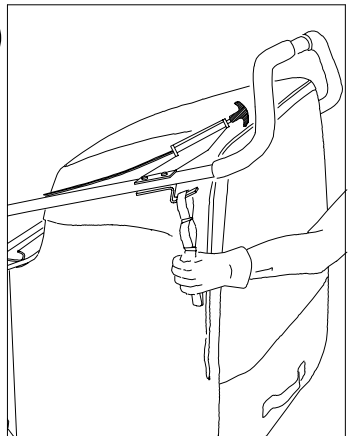

4. **ATTACH** bag hanger strap to bag supports (item 11), preassembled to upper handle.

4a. Bag hanger straps are designed for adjustment when more clearance is required between bag and ground. Typically the bottom loop of the strap is used when operating on turf.



PUT OIL IN ENGINE BEFORE STARTING

SEE ENGINE MANUFACTURER'S MANUAL (some engine manufacturers' have different oil checking procedures)

6.

7.

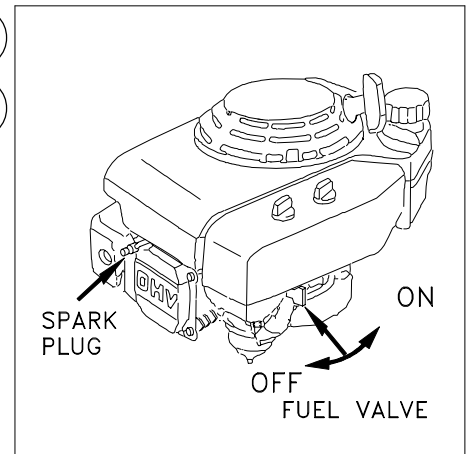

6. **CONNECT** spark plug wire.
7. **VERIFY** fuel valve on.

Operation

INTENDED USE: This machine is designed for vacuuming leaves, grass clippings and other types of organic litter as well as debris mixed with cans, bottles and small amounts of sand; however, vacuuming cans, bottles and sand will affect the longevity of your machine.

 Like all mechanical tools, reasonable care must be used when operating machine.

Do not operate if excessive vibration occurs. If excessive vibration occurs, shut engine off immediately and check for damaged or worn impeller, loose impeller bolt, loose impeller key, loose engine or lodged foreign objects. Note: See parts list for proper impeller bolt torque specifications. (See trouble shooting section on page 7).

Inspect machine work area and machine before operating. Make sure that all operators of this equipment are trained in general machine use and safety.



PUT OIL IN ENGINE BEFORE STARTING.

16.1

STARTING



ENGINE: See engine manufacturer's instructions for type and amount of oil and gasoline used.

Engine must be level when checking and filling oil and gasoline.

ENGINE SPEED: Controlled by throttle lever on the handle. Under normal conditions, operate at minimum throttle to accomplish your current cleaning task.

FUEL VALVE: Move fuel valve to "ON" position (Honda only).

CHOKE: Operated with throttle control (Honda). Post to prime (Briggs & Stratton).

NOTE: Outer bag and rod (items 1 and 3) MUST depress the bag presence switch (item 17) for the unit to start. See fig.1

IF YOUR UNIT FAILS TO START:

See Troubleshooting on page 8.

16.2

VACUUMING OPERATION

VACUUM NOZZLE HEIGHT ADJUSTMENT: The vacuum nozzle is raised and lowered by pulling slightly upward on handle and pulling height adjust T-Handle (item 23) at operators left hand. Lift handle up or down to desired height, then release T-handle.

FOR MAXIMUM PICKUP: Adjust nozzle height as close to debris as possible, but without blocking airflow into the nozzle. *NOTE:* Never bury nozzle into debris.



CLEARING A CLOGGED NOZZLE



& EXHAUST: Turn engine off and wait for impeller to stop completely and disconnect spark plug wire. Wearing durable gloves, remove clog. **Danger,** the clog may contain sharp materials. Reconnect spark plug wire.

16.10

COMPOST

Vacuumed leaves, grass and other organic material from your own yard can be emptied into a pile or composter to provide enriched soil for later use as fertilizer in gardens and flower beds

Note: Allow green chips to dry before spreading around living plants.

16.3

DEBRIS BAG

Debris bags are normal replaceable wear items.



Note: Frequently empty debris to prevent bag overloading with more weight than you can lift.

Bag liners are included and available for use in various conditions where debris will be vacuumed. (see Bag Liner Options shown on page 1).

DO NOT place bag on or near hot surface, such as engine.



Be sure engine has come to a complete stop before removing or emptying bag!!

This vacuum is designed for picking up trash, organic material and other similar debris (see Safety Warnings page 2-3). Many vacuums are used where dust is mixed with trash. Your unit can intermittently vacuum in dusty areas. However, following these rules will help maintain your machine's ability to vacuum in dusty conditions:

- Run machine at idle to quarter throttle.
- Machine or pressure-wash debris bag if normal cleaning does not fully clean bag. Bag should be thoroughly dry before use.

Hint!

Having one or more spare **Felt Filter** (890435) is a good way to reduce down time while dirty bags are being cleaned.



Do not store with debris in bag. Organic debris generates heat during decomposition and could damage the bag or start a fire.

16.4

HANDLING & TRANSPORTING:

Using two people to lift machine is recommended. Lift holding the handle and front of nozzle. Secure in place during transport.

16.5

STORAGE

 Never store engine indoors or in enclosed poorly ventilated areas with fuel in tank, where fuel fumes may reach an open flame, spark or pilot light, as on a furnace, water heater, clothes dryer or other gas appliance.

If engine is to be unused for 30 days or more, prepare as follows:

 Be sure engine is cool. Do not smoke. Remove all gasoline from carburetor and fuel tank to prevent gum deposits from forming on these parts and causing possible malfunction of engine. Drain fuel outdoors, into an approved container, away from open flame. Run engine until fuel tank is empty and engine runs out of gasoline.

NOTE: Fuel stabilizer (such as Sta-Bil) is an acceptable alternative in minimizing the formation of fuel gum deposits during storage. Add stabilizer to gasoline in fuel tank or storage container. Always follow mix ratio found on stabilizer container. Run engine at least 10 min. after adding stabilizer to allow it to reach the carburetor.

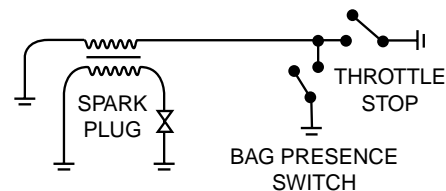
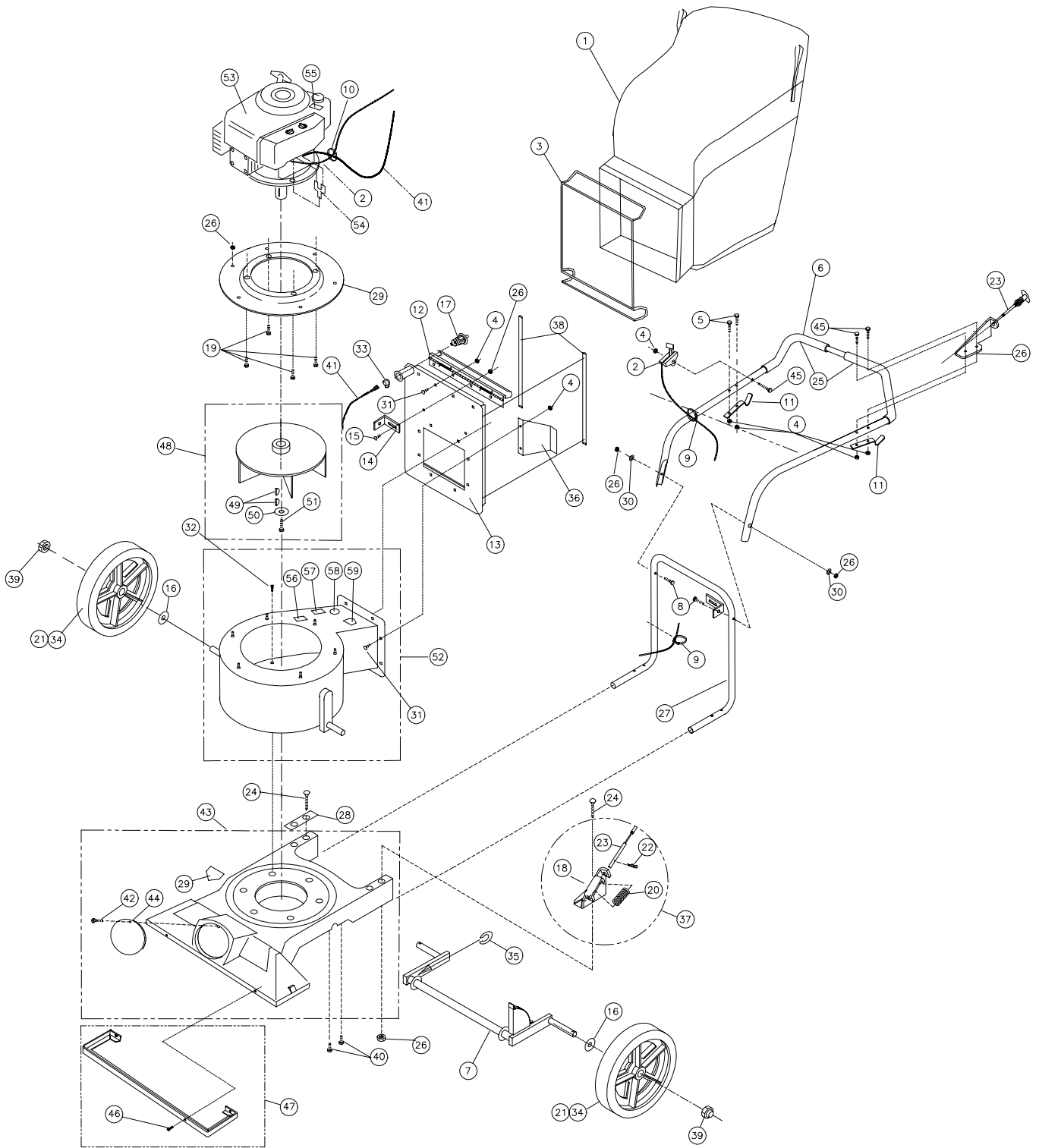

fig 1.





18 PARTS DRAWING
SV50HR

19 * Denotes standard hardware item that may be purchased locally.

Item No.	PARTS LIST	SV50HR Part No.	QTY
1	OUTER DEBRIS BAG	890351	1
2	THROTTLE CONTROL	850270	1
3	ROD BAG NO CHANNEL	890036	1
4	NUT LOCK (1/4 - 20)	*8160001	17
5	SCREW CAP (1/4 - 20 x 1-1/2 HEX)	*8041008	2
6	HANDLE UPPER W/GRIP	890439	1
7	AXLE HEIGHT ADJUST	890389	1
8	SCREW CAP 5/16 - 18 x 1-3/4	*8041031	2
9	CLAMP CABLE 1" I.D.	900813	2
10	TY WRAP	*900407	2
11	BAG BAG SUPPORT	900039	1
12	LATCH BAG	890356	1
13	PLATE BAG NO CHANNEL	890039	1
14	BRACKET HANDLE SV	890532	2
15	BOLT CARR. 5/16 - 18 x 3/4 ZP	8024039	2
16	WASHER FLAT 1/2 SAE	*8172011	4
17	SWITCH PLUNGER	890440	1
18	BRACKET - LOWER HEIGHT ADJUSTMENT	890021	1
19	SCREW 3/8 X 1 1/2 TAPTITE	890408	4
20	SPRING-COMPRESSION	900136	1
21	TIRE - ONLY (PER ASSY)	900507	1
22	PIN - HAIR COTTER	900471	1
23	CABLE HEIGHT ADJUSTMENT	890019	1
24	BOLT - CARRIAGE 5/16 - 18 x 4 1/2	*8024054	4
25	GRIP HANDLE	400570	2
26	NUT LOCK 5/16 - 18 HEX	*8160002	6
27	HANDLE LOWER	890346	1
28	PLATE HANDLE SUPPORT	900933	1
29	ENGINE PLATE MOUNT	890337	1
30	WASHER FLAT CUT 5/16	*8171003	2
31	SCREW CARRIAGE 1/4-20 x 3/4	*8024021	12
32	SCREW CAP 1/4 - 20 x 1/2 HWH	890359	6
33	STRAIN RELIEF HAYCO 1244	500282	1
34	WHEEL ASS'Y (incl. items 21)	900509	4
35	WASHER 0.75 "C"	900997	1 - 0
36	PLATE DEFLECTOR SV	890011	1
37	HEIGHT ADJUST ASSY (incl. items 18,20,22,23,25)	890013	1
38	SEAL BAG	890018	2
39	1/2-13 CAP NUT NP W/PATCH	890530	4
40	SCREW CAP 1/4 - 20 x 1 - 1/4	*8041007	4
41	HARNESS ASSY	890442	1
42	SCREW SELF TAPPING 10 - 24 x 1/2	*8123086	1
43	NOZZLE MAINFRAME ASS'Y (incl. one of items 29,44,42)	890391	1
44	PLUG HOUSING	900146	1
45	SCREW CAP 1/4-20x 1-3/4	*8041009	2
46	SCREW SM 1/4 x 3/4 TYPE A	*8122082	4
47	PLATE SKID (incl. items 78)	890413	1
48	IMPELLER ASS'Y (incl. items 49, 50, 51)	890382	1
49	KEY	900162	2
50	WASHER LOCK 3/8 TWISTED TOOTH	400502	1
51	SCREW CAP 3/8 -24 x 1 (HARDENED)(TORQ.50 FT-LBS)(68N.m)	900154	1
52	HOUSING ASS'Y (incl. items 29, 62, 84, 86)	890388	1
53	ENGINE HONDA 5.5 H.P. GXV160 KN12	900615	1
54	TERMINAL PIGGYBACK 3/16	890010	1
55	LABEL DO NOT FILL WHEN ENGINE IS HOT	400268	1
56	LABEL EAR EYE BREATHING	890254	1
57	LABEL DANGER FLYING DEBRIS	810736	1
58	LABEL READ OWNER'S MANUAL	890301	1
59	LABEL DANGER CUT FINGER	400424	2
60	PLATE UPPER HEIGHT ADJUST	890005	1

MAINTENANCE

 Use only a qualified mechanic for any adjustments, disassembly or any kind of repair .

 **WARNING: TO AVOID PERSONAL INJURY, ALWAYS TURN MACHINE OFF, MAKE SURE ALL MOVING PARTS COME TO A COMPLETE STOP.**

 **DISCONNECT SPARK PLUG WIRE BEFORE SERVICING UNIT.**

 **ENGINE:** See engine manufacturer operator's instructions.

 **RECONNECT SPARK PLUG WIRE, GUARDS, BAG, CAPS AND / OR HOSE BEFORE STARTING ENGINE.**

17.2 Maintenance Schedule Follow these hourly maintenance intervals.

Maintenance Operation	Every Use	Every 5 hrs or (Daily)
Engine (See Engine Manual)		
Check for excessive vibration		●
Clean Debris Bag	●	
Inspect for loose parts		●
Inspect for worn or damaged parts		●

17.1 IMPELLER REMOVAL For damaged or imbalanced impeller

1. Wait for engine to cool and disconnect spark plug.
2. Drain fuel and oil from the engine.
3. Remove engine, impeller and mounting plate by removing nuts (item 26) around outside of housing.
4. Leaving engine fastened to plate, remove impeller bolt (item 50) and lock washer and slide impeller off crankshaft (A puller may be required). **CAUTION:** Do not drop impeller.
5. If impeller does not slide off crankshaft, place two crowbars between impeller and housing on opposite sides. Pry impeller away from engine until it loosens. *Using a penetrating oil can help loosen a stuck impeller.*
6. If the impeller cannot be loosened, obtain a 1" (25.4mm) longer bolt of the same diameter and thread type as the impeller bolt. Invert engine and impeller and support engine above ground to prevent recoil damage. Thread longer bolt by hand into the crankshaft until bolt bottoms. Using a suitable gear or wheel puller against the bolt head and the impeller back-plate (near the blades), remove impeller from shaft.
7. To reinstall impeller, use a new impeller bolt and lockwasher
8. Tighten impeller bolt. Torque impeller bolt to 50 Ft. Lbs. (68 N·m).
9. Reinstall engine, impeller, and mounting plate onto housing in reverse order of removal.
10. Before connecting spark plug wire, slowly pull engine starting rope to insure that impeller rotates freely.
11. Reinstall spark plug wire.

TROUBLESHOOTING

Before Requesting Service Review These Suggestions

Problem	Possible Cause	Solution
Will not vacuum or has poor vacuum performance.	<ul style="list-style-type: none"> · Dirty or full debris bag or filter. · Nozzle height set too high or too low . · Hose kit cap missing. · Clogged nozzle or exhaust. · Excessive quantity of debris. 	<ul style="list-style-type: none"> · Clean debris bag and filter. Shake bag clean or wash. · Adjust nozzle height. · Check for hose kit cap. · Unclog nozzle or exhaust (see page 5) · Allow air to feed with debris.
Abnormal vibration.	<ul style="list-style-type: none"> · Loose or out of balance impeller. · Loose engine. 	<ul style="list-style-type: none"> · Check impeller and replace if required. · Check Engine.
Engine will not start.	<ul style="list-style-type: none"> · Throttle in off position. · Engine not in full choke position. · Out of gasoline or bad or old gasoline. · Spark Plug wire disconnected. · Gas Valve off. · Dirty air cleaner. · Safety Interlock disengaged on bag plate. 	<ul style="list-style-type: none"> · Check throttle · Check throttle, choke position · Check throttle, choke position and gasoline. · Connect spark plug wire. · Turn on gas valve. · Clean or replace air cleaner. Contact a qualified service person. · Bag not fully engaged or Rod in bag is bent.

Engine Service and Warranty
Contact your nearest engine manufacturer's authorized servicing dealer.

Serial Plate Record your machine model, serial number and date-of-purchase and where purchased



BILLY GOAT INDUSTRIES, INC.

1803 S.W. Jefferson
Lee's Summit,
MO 64062 / USA
Tel (816) 524-9666
Fax (816) 524-6983



109 dB

Model	Serial No.
Unit(Weight)	Engine Power
<input type="text"/> lbs. <input type="text"/> kg	<input type="text"/> kW <input type="text"/> rpm

Purchase Date _____ Purchased from _____

WARRANTY PROCEDURE

Please fill in the WARRANTY CARD and send the upper part to Billy Goat. The WARRANTY terms are stated on the lower part which remains with the user. Whenever a Billy Goat Machine is faulty due to a defect in material and / or workmanship, the owner should make a warranty claim as follows:

The Machine should be taken to the dealer from whom it was purchased or to an authorized Billy Goat dealer.

The owner should present the remaining half of the Warranty Registration Card, or, if this is not available, the invoice or receipt.

The Warranty Claim will be filled in by the authorized Billy Goat Dealer, who will send it with the faulty part to Billy Goat headquarters.

The Quality / Service department at Billy Goat headquarters will study the claim and parts and will notify their conclusions.

The decision by the Quality / Service department at Billy Goat headquarters to approve or reject a Warranty claim is final and binding.

Note: To process a Warranty Claim, it is necessary to quote the Model & Serial number who are printed on the Billy Goat Serial Plate.

BILLY GOAT  **BILLY GOAT INDUSTRIES, INC.**
1803 S.W. JEFFERSON LEE'S SUMMIT, MO 64082 / USA
PHONE: 816-524-9666 FAX: 816-524-6983 www.billygoat.com