

IN THE INTEREST OF SAFETY



BEFORE STARTING ENGINE, READ AND UNDERSTAND THE "ENTIRE OPERATOR'S MANUAL & ENGINE MANUAL."



THIS SYMBOL MEANS WARNING OR CAUTION. DEATH, PERSONAL INJURY AND/OR PROPERTY DAMAGE MAY OCCUR UNLESS INSTRUCTIONS ARE FOLLOWED CAREFULLY.



WARNING!

The engine exhaust from this product contains chemicals known to the State of California to cause cancer, birth defects or other reproductive harm.

WARNING: DO NOT

1. **DO NOT** run engine in an enclosed area. Exhaust gases contain carbon monoxide, an odorless and deadly poison.

2. **DO NOT** place hands or feet near moving or rotating parts.

3. **DO NOT** store, spill or use gasoline near an open flame, or devices such as a stove, furnace, or water heater which use a pilot light or devices which can create a spark.

4. **DO NOT** refuel indoors where area is not well ventilated. Outdoor refueling is recommended.

5. **DO NOT** fill fuel tank while engine is running. Allow engine to cool for 2 minutes before refueling. Store fuel in approved safety containers.

6. **DO NOT** remove fuel tank cap while engine is running.

7. **DO NOT** operate engine when smell of gasoline is present or other explosive conditions exist.

8. **DO NOT** operate engine if gasoline is spilled. Move machine away from the spill and avoid creating any ignition until the gasoline has evaporated.

9. **DO NOT** transport unit with fuel in tank.

10. **DO NOT** smoke when filling fuel tank.

11. **DO NOT** choke carburetor to stop engine. Whenever possible, gradually reduce engine speed before stopping.

12. **DO NOT** run engine at excessive speeds. This may result in injury & /or damage to unit.

13. **DO NOT** tamper with governor springs, governor links or other parts which may change the governed engine speed.

14. **DO NOT** tamper with the engine speed selected by the engine manufacturer.

15. **DO NOT** check for spark with spark plug or spark plug wire removed. Use an approved tester.

16. **DO NOT** crank engine with spark plug removed. If engine is flooded, place throttle in "FAST" position and crank until engine starts.

17. **DO NOT** strike flywheel with a hard object or metal tool as this may cause flywheel to shatter in operation. Use proper tools to service engine.

18. **DO NOT** operate engine without a muffler. Inspect periodically and replace, if necessary. If engine is equipped with muffler deflector, inspect periodically and replace, if necessary, with correct deflector.

19. **DO NOT** operate engine with an accumulation of grass, leaves, dirt or other combustible material in the muffler area.

20. **DO NOT** use this engine on any forest covered, brush covered, or grass covered unimproved land unless a spark arrester is installed on the muffler. The arrester must be maintained in effective working order by the operator. In the State of California the above is required by law (Section 4442 of the California Public Resources Code). Other states may have similar laws. Federal laws apply on federal lands.

21. **DO NOT** touch hot muffler, cylinder, or fins because contact may cause burns.

22. **DO NOT** run engine without air cleaner or air cleaner cover.

23. **DO NOT** operate during excessive vibration!

24. **DO NOT** leave machine unattended while in operation.

25. **DO NOT** park machine on a steep grade or slope.

WARNING: DO



1. **ALWAYS DO** remove the wire from the spark plug when servicing the engine or equipment TO PREVENT ACCIDENTAL STARTING.

2. **DO** keep cylinder fins and governor parts free of grass and other debris which can affect engine speed.

3. **DO** pull starter cord slowly until resistance is felt. Then pull cord rapidly to avoid kickback and prevent hand or arm injury.

4. **DO** examine muffler periodically to be sure it is functioning effectively. A worn or leaking muffler should be repaired or replaced as necessary.

5. **DO** use fresh gasoline. Stale fuel can gum carburetor and cause leakage.

6. **DO** check fuel lines and fittings frequently for cracks or leaks. Replace if necessary

7. **Follow** engine manufacturer operating and maintenance instructions.

8. **Inspect** machine and work area before starting unit.

TABLE OF CONTENTS

SAFETY INSTRUCTIONS	2
GENERAL SAFETY	3
ASSEMBLY	3
PARTS BAG & CONTROLS	4
LABELS	4
OPERATION	5 - 7
MAINTENANCE	8 - 9
PARTS DRAWING & LIST	10 - 12
TROUBLESHOOTING	12
WARRANTY	12

Part No. 790161

SOUND

SOUND TESTS

Sound tests conducted were in accordance with 79/113/EEC and were performed on 05/07/98 under the conditions listed:

GENERAL CONDITION: Partly Cloudy

89

94

TEMPERATURE: 69°F (20.6°C)

WIND SPEED: 8 MPH (12.8 kmh)

WIND DIRECTION: N

HUMIDITY: 76 %

BAROMETRIC PRESSURE: 29.71" Hg (755mm Hg)

VIBRATION

VIBRATION LEVEL 0.02g

Vibration levels at the operators handles were measured in the vertical, lateral, and longitudinal directions using calibrated vibration test equipment. Tests were performed on 05/07/98 under the conditions listed:

GENERAL CONDITION: Partly Cloudy

TEMPERATURE: 69°F (20.6°C)

WIND SPEED: 8MPH (12.8 kmh)

WIND DIRECTION: N

HUMIDITY: 76 %

BAROMETRIC PRESSURE: 29.71" Hg (755mm Hg)

GENERAL SAFETY

For your safety and the safety of others, these directions should be followed:



Do not operate this machine without first reading owner's manual and engine manufacturer's manual.



Use of Ear Protection is recommended while operating this machine.



Use of Eye and Breathing protection is recommended when using this machine, especially in dry and dusty conditions.

DO NOT place hands or feet inside nozzle intake opening, near debris outlet or near any moving parts.

DO NOT start engine without hose and exhaust elbow connected firmly in place to housing and exhaust outlet.

DO NOT allow children to operate this equipment.

DO NOT transport unit without elbow retension cable (item 87) assembled.

DO NOT operate without discharging exhaust into enclosed container.

DO NOT operate during excessive vibration.

DO NOT remove hose until engine has been turned off and has come to a complete stop.

DO NOT operate machine with hose or exhaust elbow removed.

DO NOT use this machine for vacuuming **exclusively** sand, dust, fine dirt, rock, glass, string like material, grain, rags, cans, metal, bark or water.

DO NOT operate this machine on slopes greater than 45%(25°).

DO NOT pick up any hot or burning debris, or any toxic or explosive material.

DO NOT operate this unit freestanding. Unit must be secured in place during any operation.

ASSEMBLY



Read all safety and operating instructions before assembling or starting this unit.



PUT OIL IN ENGINE BEFORE STARTING.

BATTERY NOT INCLUDED WITH UNIT.

Your Billy Goat is shipped from the factory in one carton and is completely assembled except for the exhaust elbow, nozzle, handle loop for nozzle, hose boom, hose band, hose coupler, hose clamps and related hardware.

1. **SECURELY ATTACH** unit to the bed of a truck or to a trailer, so that the exhaust discharges into an enclosed container. **NOTE:** This unit must be securely mounted to the bed of a truck or to a trailer before operating.

2. **ATTACH** hose to hose coupler, using hose clamp (item 26) **NOTE:** This unit is equipped with a unidirectional hose. Assemble hose so that interior hose material seams face toward unit. Refer to flow direction arrow printed on outside of hose. When installed arrow should point toward vac housing.

3. **ATTACH** hose coupler w/hose to housing intake, that is preassembled to housing front plate, and rotate to lock it in place.

4. **ASSEMBLE** handle loop nozzle (item 45), to nozzle handle (item 44) using capscrew (item 53), and lock nut (item 60). Adjust handle loop to desired height and angle and securely tighten in place.

5. **ASSEMBLE** nozzle handle (item 44), to nozzle (item 25), using screws (item 52), washers (item 66), washers (item 68) and lock nuts (item 60).

8. **ATTACH** assembled nozzle to hose using hose clamp (item 26). Before tightening hose clamp, position nozzle handle upward when hose is stretched to prevent twisting load on hose assembly during operation.

9. **ATTACH** preassembled hose boom to control panel located on top of housing.

10. **ASSEMBLE** hose band (item 29) around hose and secure chain between flanges of the hose band using capscrew (item 53) and lock nut (item 60) (see ADJUSTING HOSE BOOM on page 6).

11. **ATTACH** opposite end of chain to J-hook located on end of boom Assy.

12. **SECURELY ATTACH** exhaust elbow (item 21) capturing both flanges inside the clamp, then firmly tighten the clamp, securing the elbow to the housing (see MOUNTING on page 5).

13. **ASSEMBLE** battery (not included) by using battery bracket QL (item no. 70, hold down rods (item 71), washers (item 70), and lock nuts (item 59).

14. **ATTACH** red battery cable to + terminal and black battery cable to - terminal.

PACKING CHECKLIST

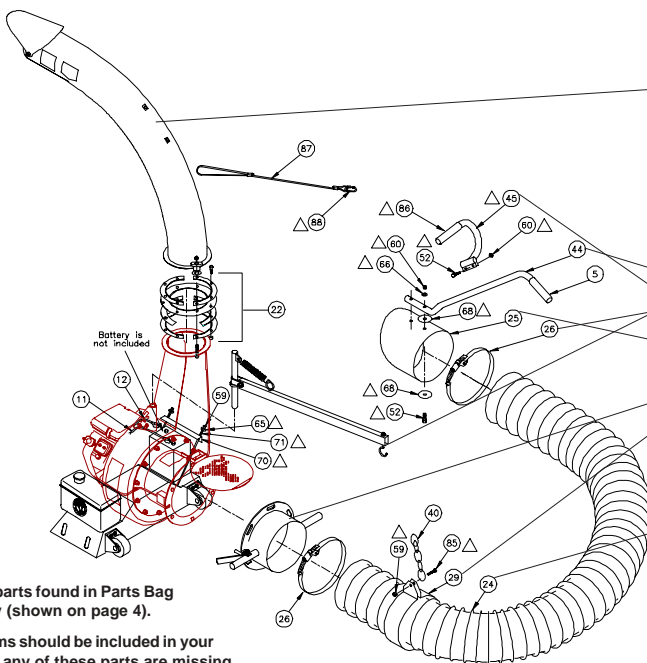







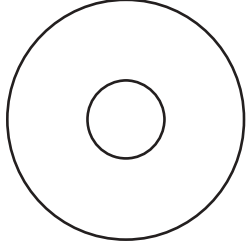
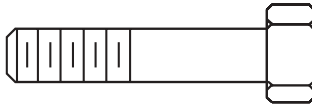

△ Denotes parts found in Parts Bag Assembly (shown on page 4).

These items should be included in your carton. If any of these parts are missing, contact your dealer.

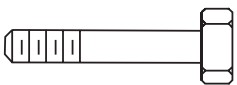
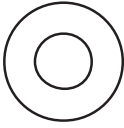
Boxing Checklist	
<input type="checkbox"/>	Exhaust Elbow Assembly
<input type="checkbox"/>	Hose Boom Assembly
<input type="checkbox"/>	Band Hose Boom 12" (305mm) 790153
<input type="checkbox"/>	Hose Clamps 12" (305mm) 790150 Qty. 2
<input type="checkbox"/>	Hose Coupler Assy
<input type="checkbox"/>	Handle Nozzle 811020
<input type="checkbox"/>	Nozzle QL 790149
<input type="checkbox"/>	Hose 12"x 10' QL 790148
<input type="checkbox"/>	Handle Loop Nozzle 811019
<input type="checkbox"/>	Parts Bag & Literature Assy 790111
<input type="checkbox"/>	Briggs & Stratton Vanguard 20 HP P/N MS-4147-7/97 Multi-Lang

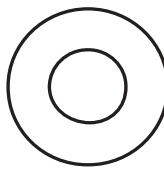
PARTS BAG & LITERATURE ASSY P/N 790111

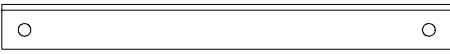
△ PARTS BAG ASSEMBLY CHECKLIST P/N 790229

- | | | | | | |
|--|---|---|--|---|--|
| 59 Nut Lock 1/4-20
8160001 Qty. 3 |  | 68 Washer 5/16
Fender
8172020 Qty. 4 |  | 52 Screw Cap 5/16-18 x 1 1/2
8041030 Qty. 4 |  |
| 60 Nut Lock 5/16-18
8160002 Qty. 4 |  | | | 85 Screw Cap 1/4-20 x 1 1/2
8041008 Qty. 1 |  |
| 65 Washer 1/4 SAE
8181008 Qty. 2 |  | | | 45 Handle Adj. W/ Grip 811019 Qty. 1 |  |
| 63 Washer 5/16 FC
8171003 Qty. 2 |  | 71 Rod Battery Hold Down 790231 Qty. 2 |  | 70 Bracket Battery QL 790230 Qty. 1 |  |
| 66 Washer 5/16
SAE 8172008
Qty. 2 | | 40 Chain Hang Hose 790189 Qty. 1 |  | | |

Literature Checklist

- | | | |
|---|--------------------------------|---|
| Owner's Manual | <input type="checkbox"/> Check | Owner's Manual
790161 |
| Literature Parts Bag | <input type="checkbox"/> Check | Literature Parts Bag
790111 |
| Warranty Card | <input type="checkbox"/> Check | Warranty Card
400972 |
| EU Declaration of Conformity & EU Distributor List | <input type="checkbox"/> Check | EU Declaration of Conformity & EU Distributor List
790162 |

INSTRUCTION LABELS

These labels should be included on your Quite Loader. If any of these labels are damaged, replace them before putting this equipment into operation. Item and part numbers are given to help in ordering replacement labels.



Label Danger Keep Hands and Feet Away
Item 3
Part No. 400424



Label Ear Eye Breathing
Item No. 49 Part No. 890254



Label Danger Flying Material
Item No. 43 Part No. 810736



Label Warning Secure
Item No. 72 Part No. 790232



Label Read Owner's Manual
Item No. 50 Part No. 890301



Label On Off Item 77
Part No. 830276



Label Do Not Fill While Engine Is Hot
Item 1 Part No. 400268

CAUTION

READ OWNER'S MANUAL BEFORE OPERATING

USE PERSONAL PROTECTION EQUIPMENT

PROTECT BYSTANDERS FLYING DEBRIS

DO NOT OPERATE UNLESS DEBRIS IS DISCHARGING INTO AN ENCLOSED CONTAINER

KEEP ENGINE CLEAN OF DEBRIS

ENGINE EXHAUST SYSTEM IS HOT. KEEP HANDS CLEAR.

BEFORE STARTING, MAKE SURE:

- EXHAUST ELBOW IS SECURELY ATTACHED.
- INTAKE HOSE IS ATTACHED.
- ALL GUARDS ARE ATTACHED.

FOR PREVENTATIVE MAINTENANCE:

- CHECK ENGINE OIL DAILY.
- INSPECT AND CLEAN ENGINE AIR FILTER DAILY. REPLACE AS NEEDED.
- INSPECT AND CLEAN ENGINE RECOIL FILTER DAILY. REPLACE AS NEEDED.
- INSPECT MACHINE BEFORE EACH USE AND REPLACE ANY WORN OR DAMAGED PARTS.
- PROPERLY SECURE EQUIPMENT BEFORE TRANSPORTING.
- DISCONNECT SPARK PLUG WIRES AND BATTERY CABLE BEFORE SERVICING UNIT.
- USE ONLY A QUALIFIED MECHANIC TO SERVICE THIS MACHINE.

Label QL Instruct/Warn
Item 18 Part No. 790142

CONTROLS

Control Panel

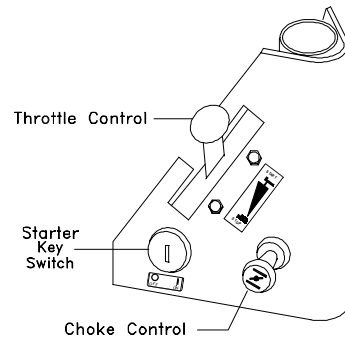

ENGINE LABELS

ENGINE MAINTENANCE

1. CHECK OIL LEVEL	8 HOURS
2. CHECK & CLEAN AIR CLEANER	25 HOURS
3. CHANGE OIL	50 HOURS
4. REPLACE OIL FILTER	100 HOURS
5. CLEAN COOLING FINS	100 HOURS

See Operating and Maintenance Instructions

IN U.S.A. USE UNLEADED GASOLINE

IMPORTANT ENGINE INFORMATION FOR GGS
STRATTON CORPORATION FAMILY
VEHICLES FROM
DEPARTMENT 790229 MODEL 210CH
THIS ENGINE CONFORMS TO 1995-1998 CALIFORNIA EMISSION
REGULATIONS FOR SMALL NONROAD ENGINES. REFER TO
OWNER'S MANUAL FOR MAINTENANCE SPECIFICATIONS AND
ADJUSTMENTS.

CAUTION

IF BATTERY IS REMOVED, DO NOT OPERATE ENGINE WITHOUT INSULATING POS + BATTERY CABLE TERMINAL WITH ELECTRICAL TAPE, OR SPARKING FROM BATTERY CABLE CAN RESULT.

OPERATION

INTENDED USE: This machine is designed for vacuuming leaves, grass clippings and other types of organic litter. Debris mixed with cans, bottles and small amounts of sand can be vacuumed; however, it is not this machine's primary purpose. Vacuuming cans, bottles and sand will affect the longevity of your machine.

Do not operate if excessive vibration occurs. If excessive vibration occurs, shut engine off immediately and check for damaged or worn impeller, loose impeller bolt, loose impeller key, loose engine or lodged foreign objects. Note: See parts list for proper impeller bolt torque specifications. (See trouble shooting section on page 12).



Like all mechanical tools, reasonable care must

be used when operating machine.

MOUNTING Main unit



GENERAL: Unit must be securely mounted to a trailer, truck bed, or other similar surface before use. Do not use this unit in a freestanding position. Unit is not stable until it has been secured in place.

Secure unit by bolting through the base of the unit and through the mounting surface using 3/8" dia. bolts, with washers and locking nuts (see fig. 1)

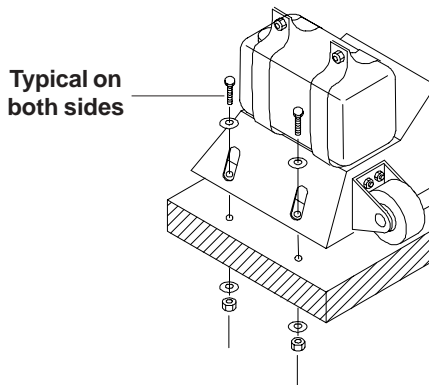

Fig. 1

MOUNTING: Unit can be mounted in various positions. Figure 2 illustrates the mounting options available when using the optional trailer (Billy Goat Part no. 790112) available from your Billy Goat dealer. The unit can be mounted to allow vacuuming from either sides as well as from the rear.

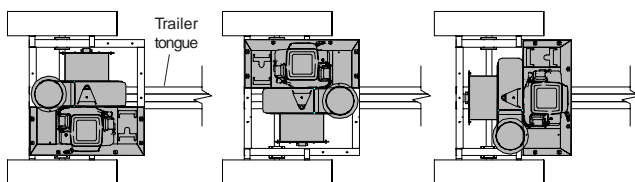
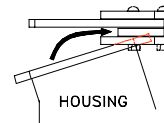

Fig. 2

MOUNTING Exhaust elbow

INSTRUCTIONS:

- 1) Remove the loose hardware from the clamp assembly so that there are 4 separate pieces (remaining clamp assembly, two half plates, and a plate split).
- 2) Slide the assembled plates over the housing flange. The flange should rest between the bottom plate and the plate split.



- 3) Slide the elbow over the plate spacer and center it in the clamp. The elbow flange should now be resting on the housing flange between the plate split and the top plate.

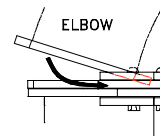

- 4) Insert the other plate split beneath the plate spacer so the holes align and the plate overlaps the flange on the elbow.

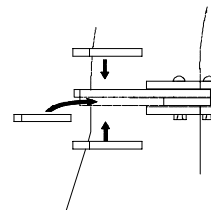

- 5) Secure the assembly with a plate half on top of the elbow flange and a plate half on bottom of the housing flange using 3, 1" carriage bolts and 3 lock nuts (removed hardware in step 1).

- 6) Tighten down the clamp with 2, 1 3/4" carriage bolts, 2 knobs, and 2 lock nuts (removed hardware in step 1).

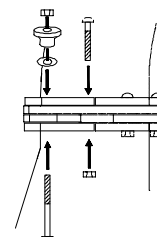

OPERATION continued

STARTING

 **PUT OIL IN ENGINE BEFORE STARTING.**

Inspect machine work area and machine before operating. Make sure that all operators of this equipment are trained in general machine use and safety.



ENGINE: See engine manufacturer's instructions for type and amount of oil and gasoline used. Engine must be level when checking and filling oil and gasoline.

ENGINE SPEED: Controlled by throttle lever on the vac housing. Under normal conditions, operate at minimum throttle to accomplish your current cleaning task.

INTAKE HOSE: Hose mounting assembly must be properly attached to vac housing and safety switch must be engaged before engine will start. Note: Any damage to the switch or wiring harness will prevent engine from starting.

CHOKE: Located on the vac housing as part of the engine control panel.

THROTTLE: Move throttle control to fast position.

KEY SWITCH: Turn to start position until engine begins to fire, immediately release the key to the run position.

Note: Do not hold key in start position more than 10 seconds per attempt.

IF YOUR UNIT FAILS TO START:

See Troubleshooting on page 12. Also see engine owner's manual.

OPERATION



**DO NOT OPERATE UNLESS
DEBRIS IS DISCHARGING
INTO AN ENCLOSED
CONTAINER**



KEEP ENGINE CLEAN OF DEBRIS

EXHAUST DIRECTION & DISTANCE: Exhaust direction and distance are controlled by the angle of the exhaust deflector and by rotation of the exhaust elbow. Adjust the angle of the exhaust deflector to control the distance that debris is discharged. Typically debris is aimed to discharge to the rear of the container. The direction of discharge is adjusted by loosening the knobs on the exhaust elbow clamp and rotating the elbow to the desired direction.

NOTE: Elbow is heavy. Use caution when adjusting. Never stand directly under the elbow while adjusting direction of exhaust.

 **Never adjust exhaust deflector angle or direction of discharge while unit is running.**

 **Never direct exhaust into an area where bystanders may cross the path of the debris.**

INTAKE OPERATION: With machine running and fully assembled, move the nozzle in sweeping motions over debris. Always allow air to flow into the nozzle along with the debris. Do not completely block the nozzle when vacuuming, it will reduce performance, and increase clogging (See figure 3).

For removal of heavier debris, or debris that is stuck to the ground, rock nozzle forward to concentrate suction power around the debris (See figure 4).

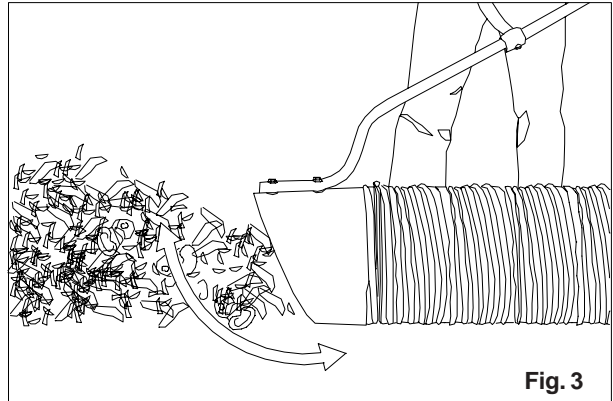

Fig. 3

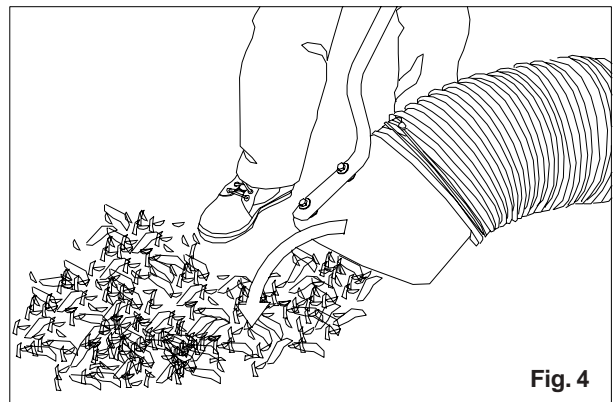

Fig. 4

HOSE CARE & USE TIPS

THE HOSE IS A REPLACEABLE WEAR ITEM.

FOR BEST HOSE OPERATION RESULTS, FOLLOW THESE RECOMMENDATIONS.

Be sure the hose is correctly installed by checking that the arrow printed on the hose indicating flow direction is pointing toward the vac housing.

Keep hose as straight as possible and avoid sharp bends during operation for best pick-up and to avoid clogs.

Never drag hose. Always remove and store hose before transporting unit.

Store hose straight and flat to maintain flexibility for next use.

To increase hose life, periodically rotate hose and reposition nozzle and coupler on front plate of unit. This increases hose life by keeping hose from wearing only on one side.

ADJUSTING HOSE BOOM:

Properly adjusting the boom will prevent most hose clogs from occurring and will maximize vacuum performance by keeping the hose straight and perpendicular to the housing (see fig. 5).

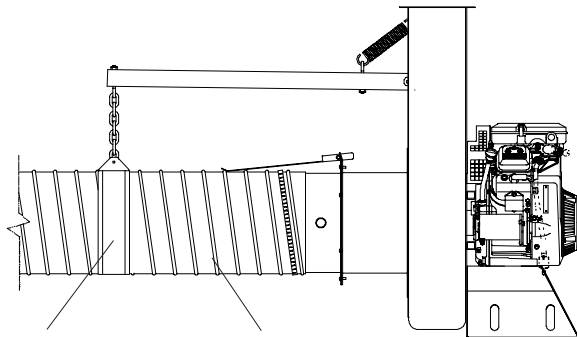

**Hose Bands.
Stretch hose
out before
clamping.**

Hose

Fig. 5

UNCLOGGING A CLOGGED HOSE:



With engine running and unit secured to a trailer, truck bed, or other similar surface, fully stretch hose in a straight line to dislodge the clog. If the clog will not clear, turn unit off, and allow engine to come to a complete stop. Remove hose and manually clear hose clog.

NOTE: The clogged debris may be sharp. Always wear durable gloves when removing a clog.

UNCLOGGING A CLOGGED HOUSING OR EXHAUST ELBOW:



Turn engine off and wait for impeller to come to a complete stop. Disconnect spark plug wires and battery cables. Remove the hose coupler from the housing and determine where the clog is located. If possible clear the clog through the intake opening. It may require removal of the intake adaptor (item 33) to allow access to clear the housing. If clog is in the elbow, carefully remove the elbow. Remove elbow by removing the knobs on the elbow clamp. Then remove 3 bolts so that the split plate can be taken out. Finally, the elbow can be removed by sliding it past the remaining attached clamp.

NOTE: Elbow is very heavy. Do not stand directly under elbow during removal.

Danger, the clog may contain sharp materials. Wearing durable gloves, clear the clog. Reconnect spark plug wire.

**HANDLING & TRANSPORT-
ING**

The unit is equipped with small front wheels to allow for easier transportation to storage. With unit removed from its mounting, tilt unit forward toward the ground and use wheels to maneuver it into storage area.

⚠ ALWAYS REMOVE HOSE BEFORE TRANSPORTING UNIT

STORAGE

Drain all fuel prior to storage.

⚠ Never store engine indoors or in enclosed poorly ventilated areas with fuel in tank, where fuel fumes may reach an open flame, spark or pilot light, as on a furnace, water heater, clothes dryer or other gas appliance.

If engine is to be unused for 30 days or more, prepare as follows:

⚠ Be sure engine is cool. Do not smoke. Remove all gasoline from carburetor and fuel tank to prevent gum deposits from forming on these parts and causing possible malfunction of engine. Drain fuel outdoors, into an approved container, away from open flame. Run engine until fuel tank is empty and engine runs out of gasoline.

NOTE: Fuel stabilizer (such as Sta-Bil) is an acceptable alternative in minimizing the formation of fuel gum deposits during storage. Add stabilizer to gasoline in fuel tank or storage container. Always follow mix ratio found on stabilizer container. Run engine at least 10 min. after adding stabilizer to allow it to reach the carburetor.

⚠ HOSE STORAGE: Store hose as straight and flat as possible. Storing hose in a covered area, out of sunlight and heat will prolong hose life. Do not store hose where it could be stepped on or where other objects could crush or damage hose.

MAINTENANCE



USE ONLY A QUALIFIED MECHANIC FOR ANY ADJUSTMENTS, DISASSEMBLY OR ANY KIND OF REPAIR.



WARNING: TO AVOID PERSONAL INJURY, ALWAYS TURN MACHINE OFF, MAKE SURE ALL MOVING PARTS COME TO A COMPLETE STOP.



DISCONNECT SPARK PLUG WIRES & BATTERY CABLES BEFORE SERVICING UNIT.



ENGINE: SEE ENGINE MANUFACTURER OPERATOR'S INSTRUCTIONS.



RECONNECT ALL GUARDS GUARDS AND HOSE BEFORE STARTING ENGINE.



USE ONLY BILLY GOAT ORIGINAL EQUIPMENT PARTS FOR REPLACEMENT AND REPAIR

GENERAL

Replace any worn or damaged parts as required.

DO NOT operate if excessive vibration occurs. If excessive vibration occurs, shut engine off immediately. Remove spark plug wire and check for damaged impeller, loose impeller bolt, loose impeller key or lodged foreign objects. Refer to parts list (item 16) on page 11 for proper torque specifications.

ENGINE

Remove and Service foam air cleaner and inner air filter every 25 hours of use or every 10 hours or less for extremely dusty conditions (see engine manual).

Keep engine and engine cooling fins clean from dust and debris build-up.

When servicing engine refer to specific manufacturers engine owner's manual. All engine warranty is covered by the specific engine manufacturer. If your engine requires warranty or other repair work contact your local servicing engine dealer. When contacting a dealer for service it is a good idea to have your engine model number available for reference(See table page 1). If you can not locate a servicing dealer in your area you can contact the manufacturers national service organization.

To reach:

Briggs & Stratton: 800-233-3723 Fax: 414-259-5249

IMPELLER REMOVAL

1. Wait for engine to cool and disconnect spark plugs from the both sides of the engine.
2. Disconnect the negative battery cable (black) (item 12) from the battery.
3. Remove the hose coupler assy from the unit (item 36).
4. Remove the hose boom assembly.
5. Remove the intake housing assembly (item 33) using 1/2" socket and socket wrench to remove (12) locknuts and washers (item 60 & 63). Be careful to place intake assembly to the side without putting excess strain on safety switch wire harness
6. Remove impeller bolt and lock washer using 5/8" socket and impact wrench (see fig. 6).
7. Once bolt is removed impeller should slide out freely. If impeller will not slide free on crankshaft, obtain a 3/4"-10 x 3" bolt and thread it into the nut that is welded onto the center of the impeller and tighten slowly to push the impeller off the crankshaft.

Note: 3/4"-10 x 3" bolt is included in each impeller replacement kit or the bolt can be ordered from your local Billy Goat Dealer (part no. 790214).

8. When impeller is free of the engine shaft, align impeller with the opening and pull it straight out of the housing.
9. Using a new impeller bolt, washer, and lockwasher, reinstall new or repaired impeller in reverse order.
10. Tighten impeller bolt. Torque impeller bolt to [60 Ft. Lbs. (81.4 N-m)].
11. Repeat steps 2 through 5 in reverse order.
12. Reinstall spark plug wires.

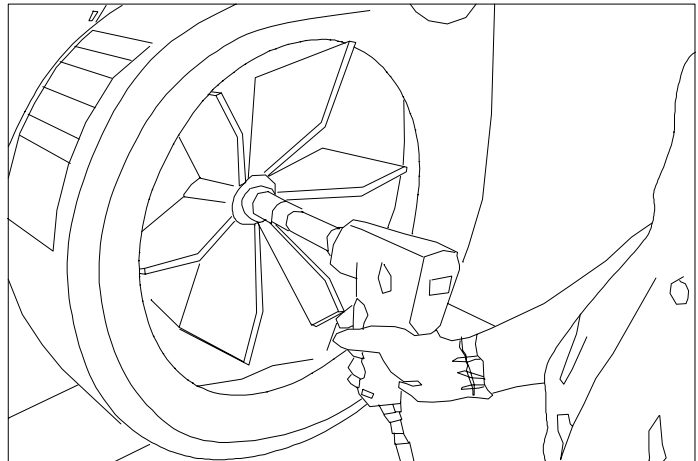
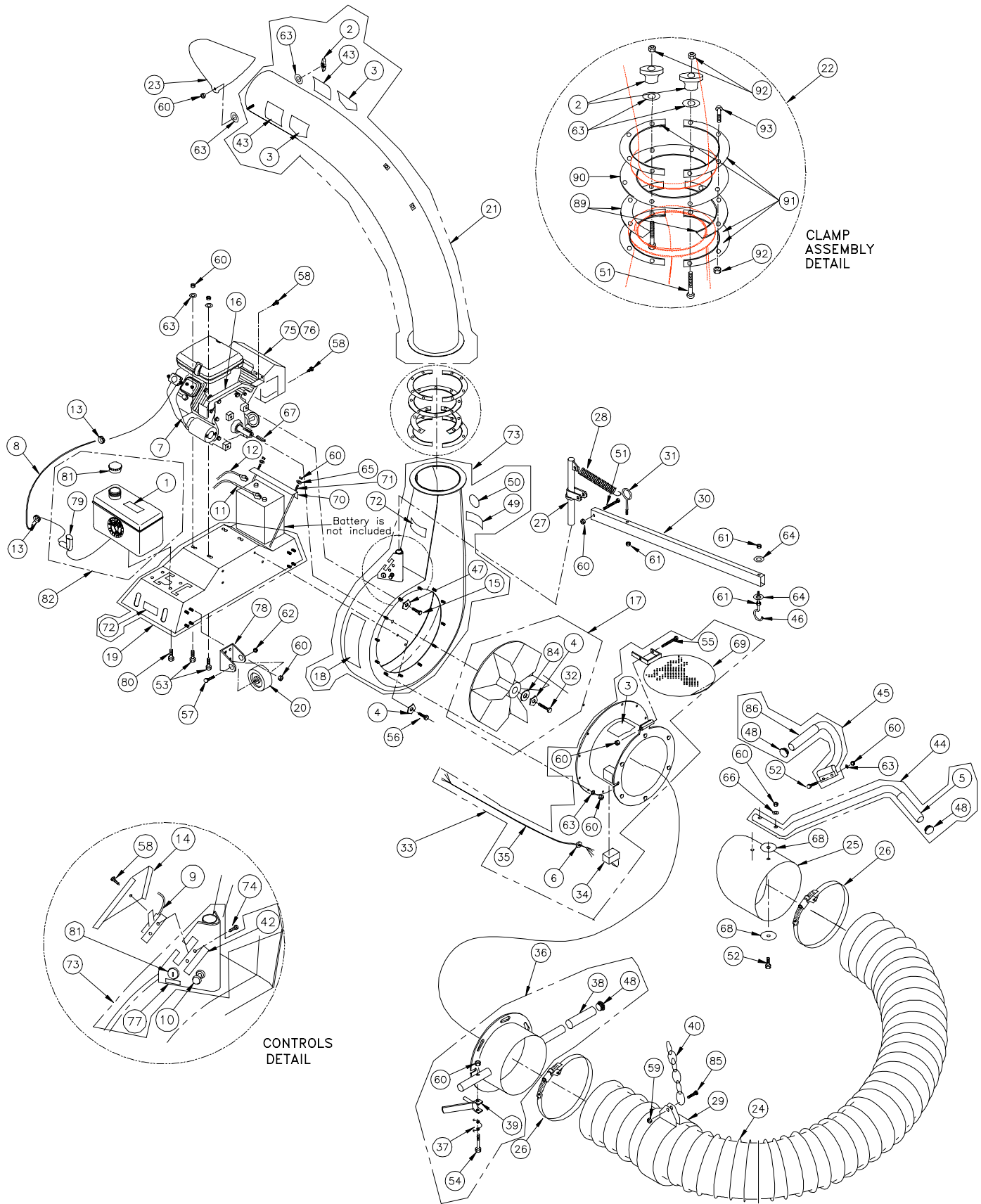

Fig. 6



PARTS DRAWING
QL2000VE

Parts List

ITEM NO.	PART NO.	DESCRIPTION	QTY
1	400268	LABEL HOT ENGINE	1
2	400339	KNOB	3
3	400424	LABEL OPEI WARNING	3
4	400502	WASHER LOCK 3/8 TWIST	5
5	400570	GRIP HANDLE 1" x 13"	1
6	500282	STRAIN RELIEF HEYCO 1244	1
7	790100	ENGINE 20 HP HORIZ. VANGUARD	1
8	790129	LINE FUEL QL	1
9	790130	CONTROL THROTTLE QL	1
10	790131	CONTROL CABLE CHOKE	1
11	790132	CABLE BATTERY RED 26"	1
12	790133	CABLE BATTERY BLACK 10"	1
13	790134	CLAMP FUEL LINE	2
14	790135	COVER CONTROL QL	1
15	790136	SCREWCAP 7/16-14 x 1 3/4" GR. 5	4
16	790137	GUARD MANIFOLD GUARD	1
17	790103-S	IMPELLER 16" x 1.12" ASSY QL (INCL. 4,32,84)	1
18	790142	LABEL QL INSTRUCT/WARN	1
19	790143-S	BASE ENGINE ASSY QL(INCLUDES 72)	1
20	790144	WHEEL 4" DIA. X 2" W/SPANNER	2
21	790145-S	ELBOW 8" ASSY QL(INCLUDES 2,3,43)	1
22	790255-S	CLAMP ASSEMBLY	1
23	790147	DEFLECTOR EXHAUST QL	1
24	790211	HOSE 12" x 10' INTAKE W/WEARSTRIP	1
25	790149	NOZZLE INTAKE 12" FORMED	1
26	790150	CLAMP HOSE 12"	2
27	790151	ROD PIVOT BOOM WA QL	1
28	790152	SPRING BOOM QL	1
29	790153	BAND HOSE BOOM 12" FORMED	1
30	790154	ARM BOOM QL	1
31	790155	BOLT EYE 3/8" x 4"	1
32	500269	SCREWCAP 7/16-20X3" GR.8 [TORQUE 60 ft.lb. (81.4Nm)]	1
33	790140-S	INTAKE HOUSING ASSY QL(INCL. 3,6,34,35,55,60,63,69)	1
34	790174	SWITCH INTERLOCK QL	1
35	790175	HARNESS WIRE ASSY QL	1
36	790141-S	HOSE INTAKE ASSY QL (INCLUDES 37,38,39,48,54,60)	1
37	790178	SPRING LOCK LATCH QL	1
38	790179	GRIP 1" ID x 4" LG	2
39	790187	LEVER LOCK QL	1
40	790189	CHAIN HANG HOSE QL	1
41			
42	810656	LABEL THROTTLE	1
43	810736	LABEL FLYING DEBRIS	2
44	811020	HANDLE NOZZLE W/ GRIP	1
45	811019	HANDLE ADJ. NOZZLE W/ GRIP	1
46	790238	BOLT J-HOOK	1
47	850132	WASHER LOCK 7/16 TWIST	4
48	890132	PLUG RD 1"	4
49	890254	LABEL EAR EYE BREATHE	1
50	890301	LABEL READ	1
51	*8024043	BOLT CARRAIGE 5/16-18 x 1 3/4	3
52	*8041030	SCREWCAP 5/16-18 x 1 1/2	4
53	*8041031	SCREWCAP 5/16-18 x 1 3/4	4
54	*8041033	SCREWCAP 5/16 - 18 x 2 1/4"	1
55	*8024050	BOLT CARR. 5/16 - 18 x 3 1/2	1
56	*8041051	SCREW CAP 3/8 - 16x 1 1/4	4
57	*8041104	SCREWCAP 1/2-13 x 3 1/2"	2
58	*8122082	SCREW SM 1/4 x 3/4	6
59	*8160001	NUT LOCK 1/4"-20 HEX Z/P	3
60	*8160002	NUT LOCK 5/16-18	32
61	*8160003	NUT LOCK 3/8	3
62	*8161044	NUT LOCK 1/2-13 THIN	2

* Denotes standard hardware item that may be purchased locally.

Parts List continued from page 11.

63	*8171003	WASHER 5/16 FLAT CUT	22
64	*8171004	WASHER FLAT 3/8	2
65	*8172007	WASHER 1/4 SAE	2
66	*8172008	WASHER 5/16 SAE	2
67	*9201125	KEY 1/4 x 2 3/4	1
68	*8172020	WASHER 5/16 FENDER	4
69	790163	DOOR FLAPPER INTAKE QL WA	1
70	790230	BRACKET BATTERY QL	1
71	790231	ROD BATTERY HOLD DOWN	2
72	790232	LABEL WARNING SECURE	3
73	790125-S	HOUSING ASSY QL (INCLUDES 18,49,50,72)	1
74	430208	SHEET METAL SCREW 1/4 x 3/4 DRILL POINT	2
75	790138-01	GUARD MUFFLER GUARD	1
76	790138-02	GUARD MUFFLER GUARD BOTTOM	1
77	830276	LABEL ON / OFF	1
78	790228	BRACKET WHEEL QL	2
79	790240	90 DEGREE ELBOW 1/8" NPT MALE X 1/4"	1
80	*8041026	SCREWCAP 5/16-18 X 3/4 HCS ZP	4
81	790258	CAP TANK FUEL 3 GAL	1
82	790257	TANK FUEL 3 GAL ASSY	1
83	790100-04	IGNITION SWITCH	1
84	850443	WASHER PLATE IMPELLER	1
85	8041008	SCREWCAP 1/4-20 x 1 1/2	1
86	500267	GRIP HANDLE 1" x 7.5"	1
87			
88			
89	790254	PLATE CLAMP SPLIT	2
90	790253	PLATE CLAMP SPACER	1
91	790252	PLATE CLAMP HALF	4
92	8163002	LOCK NUT 5/16-18 THIN ZP	8
93	8024040	BOLT CARRIAGE 5/16-1" ZP	6

* Denotes standard hardware item that may be purchased locally.

△ BRIGGS & STRATTON PART NUMBERS. AVAILABLE THROUGH BRIGGS & STRATTON SERVICING DEALERS

TROUBLESHOOTING Before Requesting Service Review These Suggestions

Problem	Possible Cause	Solution
Engine will not start. (starter does not turn)	<ul style="list-style-type: none"> - Battery is low or dead. - Battery cable is disconnected or battery terminal is corroded. - Hose coupler is not installed, allowing interlock switch to operate. - Harness wire is bad or disconnected from interlock switch. 	<ul style="list-style-type: none"> - Charge battery or replace if the battery does not hold charge. - Clean battery terminal and cable then reconnect. - Install hose coupler securely to the unit and check whether interlock switch is engaged by lever. - Check harness wire connection and replace if necessary.
Engine will not start. (starter turns)	<ul style="list-style-type: none"> - Throttle stop switch in idle position. - Out of gasoline. Bad or old gasoline. - Spark Plug wire disconnected. - Dirty air cleaner. 	<ul style="list-style-type: none"> - Check throttle. - Check gasoline, Replace if gasoline is old. - Connect spark plug wire. - Clean or replace air cleaner. Or contact a qualified service person.
Will not vacuum or has poor vacuum performance.	Nozzle height too high or too low. Clogged hose or exhaust. Excessive quantity of debris.	Adjust nozzle position. Unclog hose or exhaust (see page 6). Allow air to feed with debris.
Abnormal vibration.	Loose or out of balance impeller or loose engine.	Check impeller and replace if required. Check Engine.
Engine is locked, will not turn over.	Debris locked inside impeller. Engine problem.	See page 6, Clearing a clogged impeller housing. Contact an engine servicing dealer for engine problems.

Engine Service and Warranty
Contact your nearest engine manufacturer's authorized servicing dealer.

Serial Plate *Record your machine model, serial number and date-of-purchase and where purchased*





1803 S. Jefferson
P.O. Box 308
Lee's Summit,
MO 64063 / USA
Tel (816) 524-9666
Fax (816) 524-6983



Model	Serial No.
Unit (Weight)	Engine Power
lbs. kg	kw rpm

Operator _____

Purchase Date _____ **Purchased from** _____

WARRANTY PROCEDURE

Please fill in the WARRANTY CARD and send the upper part to Billy Goat. The WARRANTY terms are stated on the lower part which remains with the user. Whenever a Billy Goat Machine is faulty due to a defect in material and / or workmanship, the owner should make a warranty claim as follows:

The Machine should be taken to the dealer from whom it was purchased or to an authorized Billy Goat dealer.

The owner should present the remaining half of the Warranty Registration Card, or, if this is not available, the invoice or receipt.

The Warranty Claim will be filled in by the authorized Billy Goat Dealer, who will send it with the faulty part to Billy Goat headquarters.

The Quality / Service department at Billy Goat headquarters will study the claim and parts and will notify their conclusions.

The decision by the Quality / Service department at Billy Goat headquarters to approve or reject a Warranty claim is final and binding.

Note: To process a Warranty Claim, it is necessary to quote the Model & Serial number who are printed on the Billy Goat Serial Plate.



BILLY GOAT INDUSTRIES INC.
1803 S.W. JEFFERSON STREET / LEE'S SUMMIT, MO 64082-2312 / USA
PHONE: 816-524-9666 FAX: 816-524-6983 www.billygoat.com